

SOG VS NOK

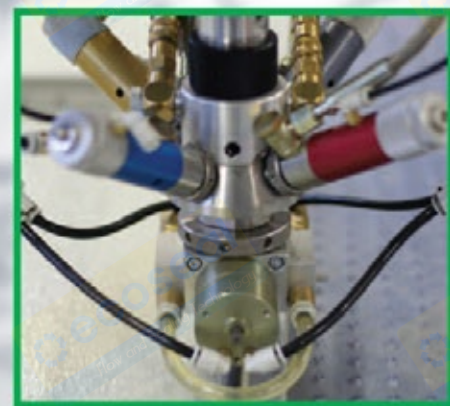

SOG VS NOK





SOG PRODUCTS

OIL SEALS FOR INDUSTRIES AND VEHICLES

Oil seals are used for rotating shafts. Sog offer a comprehensive range of oil seals for industries and vehicles.

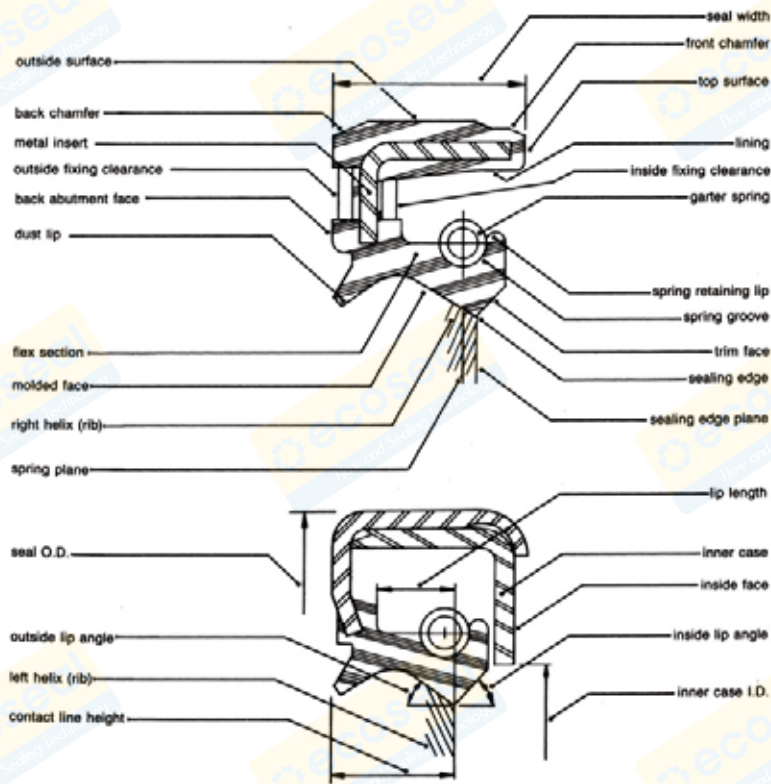

Charts of sog designs for oil seals Designs of rubber outer diameter

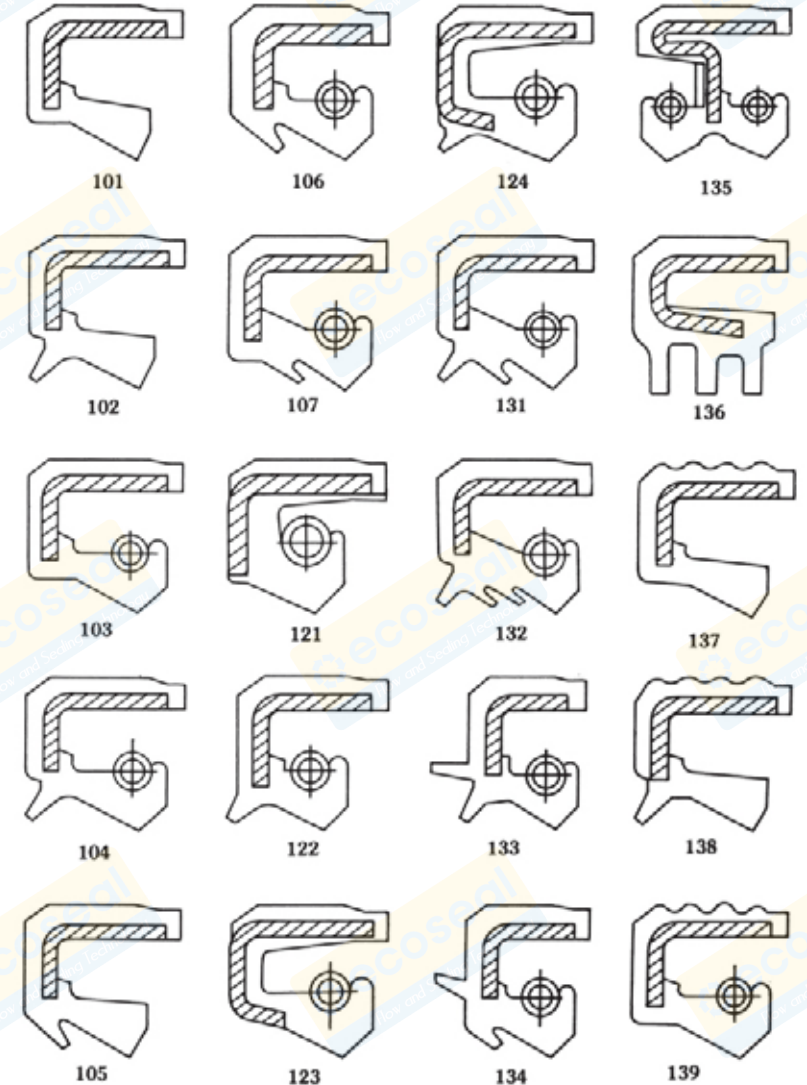

SO GIANT OIL SEAL

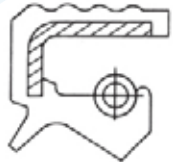

140

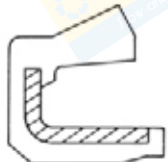

171

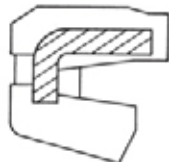

181



141



172

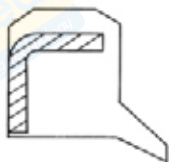

182



142

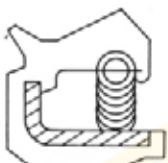

173



143

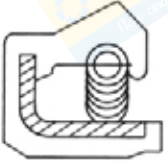

174



SO GIANT OIL SEAL

Designs of metal outer diameter



201



206



211

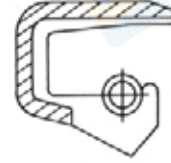

223

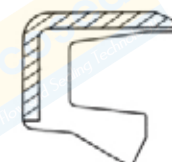

202

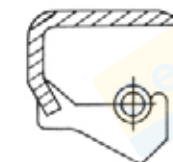

207



212

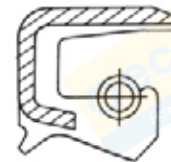

224



203

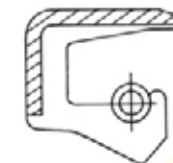

208



213



231



204



209

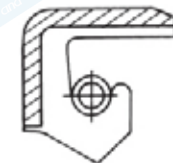

221



232

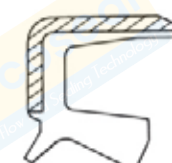

205



210

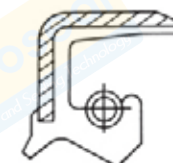

222

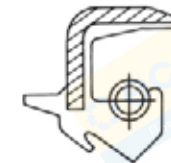

233

SO GIANT OIL SEAL



234

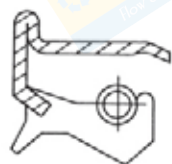

239



244

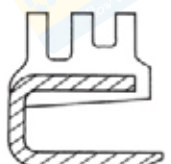

273



235

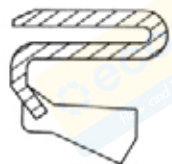

240

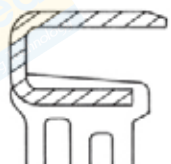

245



281

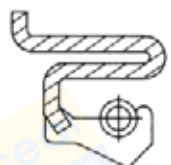

236



241

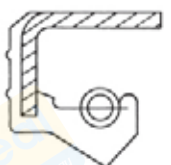

246

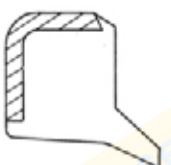

282



237



242



271

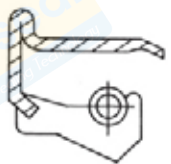

238



243

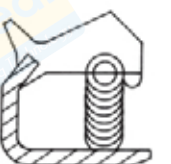

272



SO GIANT OIL SEAL

Designs of metal outer diameter with inner case

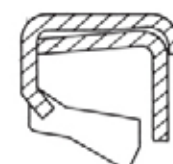

301



321



333



302



322

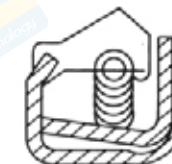

371



303

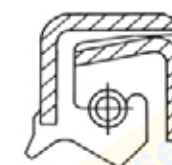

323



372



304

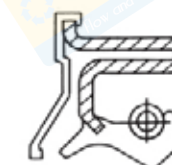

331

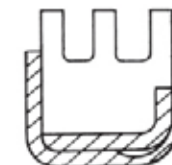

373





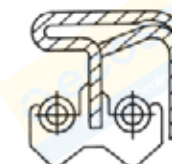

















305



332

◆TYPE of OIL SEAL

NOK TYPE	SOG Design	NOK TYPE	SOG Design
MUSASHI TYPE		MUSASHI TYPE	
VC KE	 101	KC KES-1	 102
SC AD	 103	TC UE	 104
KC3 KES-3	 105	TC9 UES-9	 133
DC YD	 135	OVC SF	 171
OKC SFS-1	 172	OTC SDS-1	 173
OSC SD	 174	VB KD	 203
KB KDS-1	 205	SB AC	 207
TB UD	 210	TB3 UDS-3	 213
TB9 UDS-9	 232	OTB SCS-1	 272
SA ACS-2	 303	TA UDS-2	 304

Helix Code : RM -- Helix line clockwise RH -- Helix line anti-clockwise
 RB -- Helix line bi-directional

Material Code : N-- Nitrile rubber S -- Silicone rubber
 P-- Polyacrylate rubber Y -- Special material

SO GIANT OIL SEAL



Interchange for popular designs

SO GIANT	103	104	207	210	303	304
DIN 3760	A	AS	B	BS	C	CS
CFW	BA	BASL	B1	B1 SL	B2	B2 SL
GOETZE	827N	827S	822N	822S	824N	824S
KACO	DG	DGS	DF	DFS	SFK	DFSK
STEFA	CB	CC	BB	BC	DB	DC
NOK	SC	TC	SB	TB	SA	TA

BONDED SEALS

The bonded seals is a static seals which are used as a sealing ring fitted under bolt heads and nuts. In order to avoid any damage on the sealing lip, the inside diameter of bonded seals should be larger than the external thread diameter and the rubber should be bonded to the inside metal only.

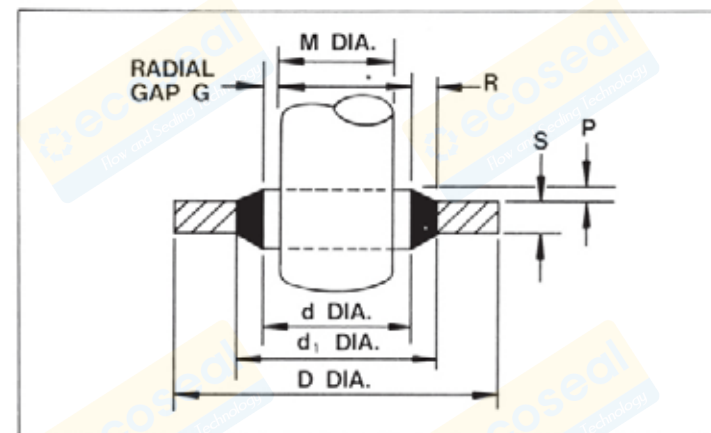

NOK_NO	NOK		SOG		
	TYPE	SIZE	SOG_NO	TYPE3	PART_NO
BHH277-A02X0	HKCY	4.8 25 5.5 6.2A727			
BGG639-A00	VC	5 11 3	113356N	VC	5*11*3
BFF576-A0	KB	5 14 5	431682N	KB	5*14*5
BZZ380-A00	Y	5.5 16 8			
BEE901-A00	TCY	6 13 4.5 7.5 B			
AE0050-E0	TC	6 16 5	100360N	TC	6*16*5
AC0105-E0	SC	7.94 19.05 6.4 *			
ACC242-A01	SC	8 14 4	101621N	SC	8*14*4
AEE844-A03	TC	8 16 7	104645N	TC	8*16*7
BRR468-A0	TC4	8 16 7.5 A400			
AR0139-E0	KC3Y	8 17.4 5 7			
AE0145-I0	TC	8 18 7	104259N	TC	8*18*7
AEE028-A00X0	TC	8 22 6 A795	106744N	TC	8*22*6
WC0087-A0	SC	8 22 7	106427N	SC	8*22*7
AP0158-F10X9	TCV	8 22 7	432106N	TCN	8*22*7
AEE289-A00X0	TC	8 25 8 A727	108425N	TC	8*25*8
AEE524-A0	TC	9 18 7	104163N	TC	9*18*7
BCC646-A02	SC	9.52 20 5			
AE0205-A0	TC	9 22 7	108896N	TC	9*22*7
AF0243-E0	VB	10 17 3	101616N	VB	10*17*3
ABB924-A0	SB	10 17 5	104149N	SB	10*17*5
ABB569-A0	SB	10.3 17 4			
BEE710-B0	TC	10 18 5 T945	103578N	TC	10*18*5
ACC645-A0	SC	10 18 6	105091N	SC	10*18*6
AEE132-A0	TC	10 19 7 A103	101635N	TC	10*19*7
AC0256-E0	SC	10 20 4	111975N	SC	10*20*4
AE0258-G0	TC	10 20 5	106313N	TC	10*20*5
BBB641-A0	SB	10 20 5	430645N	SB	10*20*5
AEE462-A0	TC	10 20 7 A727	115385N	TC	10*20*7
BEE413-A0	TC	10 22 6 A727	109386N	TC	10*22*6
AEE208-A0	TC	10 22 7 A727	100084N	TC	10*22*7
ACC591-A00	SC	10 24 7	105092N	SC	10*24*7
AF0275-E03X8	VB	10 25 4.5			
AE0276-E0	TC3	10 25 5			
AEE463-A0	TC	10 25 7	102712N	TC	10*25*7
AP0279-E10X4	TCV	10 25 7			
BEE122-A0	TC	10 26 5.5 A727			
ACC627-A0	SC	10 26 7	101545N	SC	10*26*7
AES627-A00	TC	10 26 7	100589N	TC	10*26*7
BCC196-A00	SC	10 30 7	103978N	SC	10*30*7
ACC687-A0	SC	11 17 4 A727	110847N	SC	11*17*4
BCC417-A0	SC	11 18 4	108558N	SC	11*18*4
BD3805-E0	TBY	11 18 4.8			
AE0308-E01C4	TC	11 22 7	100426N	TC	11*22*7
AEE373-B0	TC	11.6 24 10	111541N	TC	11.6*24*10
BG1642-E0	VC	11.9 25 4.5 B			
BCC555-A00X0	SC	11.9 25 5 T303			
BZ3077-E1	Y	11.8 28 7.5 9 B			
AEE558-A0	TC	12 18 5	109484N	TC	12*18*5

NOK_NO	NOK		SOG		
	TYPE	SIZE	SOG_NO	TYPE3	PART_NO
BEE083-A00	TC	45 61 9	111603N	TC	45*61*9
AEE178-A02	TC	45 62 8	103705N	TC	45*62*8
AE2651-A05M3	TC	45 62 9 A727	104049N	TC	45*62*9
AP2651-G0	TCV	45 62 9			
ADD194-A0	TB2	45 62 9	102547N	TB	45*62*9
AP2653-E0	TCN	45 62 12			
AD8399-F0	TB2	45 63 7	103522N	TB	45*63*7
AH8507-E0	HTC9	45 64 9 11.7 B R			
	VC	45 65 5			
AFF133-A00	VB2	45 65 5	101093N	VB	45*65*5
AD2655-F00X8	TB2	45 65 5 *	103176N	TZ	45*65*5
WE0030-A0	TC	45 65 8	102945N	TC	45*65*8
ABB044-A00	SB2	45 65 9			
AES130-B0	TC	45 65 10	100098N	TC	45*65*10
ADD130-A02	TB2	45 65 10	105742N	TB	45*65*10
AP2659-E0	TCN	45 65 12			
ADD603-A00	TB2	45 65 12	101094N	TB	45*65*12
AG2664-A0	VC	45 68 6			
BE2698-E0	TC	45 68 8.5 T599			
AE2668-A09L6	TC	45 68 12 A727	112016N	TC	45*68*12
AP2668-A0	TCV	45 68 12	113710N	TCN	45*68*12
AH2668-I0	HTC	45 68 12 R T599	112016N	TC	45*68*12
AP2668-G1	TCN	45 68 12	400849N	TCN1	45*68*12
APP005-A0	TCV	45 68 12 F975	113710N	TCN	45*68*12
ADD005-A0	TB2	45 68 12	110005N	TB	45*68*12
AR2668-E0	TB4	45 68 12			
AP2668-O11X1	TCN	45 68 12 F624	400849N	TCN1	45*68*12
GJ2668-F0	SA1J	45 68 12			
AA2668-H0	TA2	45 68 12	190005N	TA	45*68*12
	SC	45 68 14	110837N	SC	45*68*14
AEE970-A00	TC	45 70 12	106547N	TC	45*70*12
AW8305-E0	DC	45 70 12 B			
BGG294-A00	KCY	45 72.2 7.5 8.5	105590N	KC	45*72.2*7.5/8.5
UC0442-E00B4	SC	45 72 7 *	100077N	SC	45*72*7
BEE167-A1	TC	45 72 8	102858N	TC	45*72*8
BEE117-A0	TC	45 72 10	101198N	TC	45*72*10
AEE043-A00	TC	45 72 12	105895N	TC	45*72*12
ADD043-A00	TB2	45 72 12	101544N	TB	45*72*12
BHH654-A0	HTBW	45 72 12 19.5 BR			
ACC532-A0	SC	45 75 8	101056N	SC	45*75*8
BCC369-A00	SC	45 75 10	100951N	SC	45*75*10
AEE971-A00	TC	45 75 12	106942N	TC	45*75*12
AD2691-E03C6	TB2	45 75 12	105070N	TB	45*75*12
AH2691-G0	HTBSY	45 75 12 19.3 BR			
AQ8136-P0	QLNY	45 75 13 19			
AEE933-A00	TC	45 76 12	115190N	TC	45*76*12
BH3037-E02X1	HTBW	45 78 11 18.5 BR			
ADD113-A01	TB2	45 78 12			
AEE921-A0	TC9	45 78 13 26.3			

SOG VS NOK

NOK_NO	NOK			SOG		
	TYPE	SIZE		SOG_NO	TYPE3	PART_NO
ACC497-A1	SC	12 19 4.5	A795			
AEE197-A0	TC	12 20 5	A727	103509N	TC	12*20*5
AGG550-A0	KC	12 21 4	A727			
ACC550-B0	SC	12 21 4		107850N	SC	12*21*4
ACC209-C01X0	SC	12 22 5	A727	106435N	SC	12*22*5
BH3888-E0	HTC	12.5 22.5 5	B X			
AE0371-E0	TC	12 22 7	A727	105298N	TC	12*22*7
BP2209-E0	TCV	12.5 22.5 7	B			
AD0371-E0	TB	12 22 7		112365N	TB	12*22*7
AEE549-A01B0	TC	12 22 9	A727	108293N	TC	12*22*9
AE0375-E0	TC	12 23 8		109310N	TC	12*23*8
AE0377-E0	TC	12 24 6		108294N	TC	12*24*6
AEE517-A0	TC	12 24 7	A727	100344N	TC	12*24*7
ACC237-B0	SC	12 25 4.5	A727	108937N	SC	12*25*4.5
AE0380-E0	TC	12 25 5		103809N	TC	12*25*5
UE0668-E0	TC	12 25 7	*	102648N	TC	12*25*7
AP0382-E0	TCV	12 25 7				
ACC628-A10	SC	12 26 8		104861N	SC	12*26*8
AEE253-A0	TC	12 28 7	A727	107132N	TC	12*28*7
ACC802-A0	SC	12 30 7	171A	102911N	SC	12*30*7
AE0398-E0	TC	12 32 6				
AEE965-A0	TC	12 32 7		102224N	TC	12*32*7
BFF578-A0	KB	13 20 5		112506N	KB	13*20*5
AE7741-E0	TC	13 22 7		113811N	TC	13*22*7
BEE233-A0	TC	13.7 24 5				
AE0473-E0	TC	13 25 7		106452N	TC	13*25*7
ADD245-A00	TB2	13 25 7		105542N	TB	13*25*7
AP8356-E0	TCV	13.49 26.99 7				
AE0478-A0	TC	13 28 7		101130N	TC	13*28*7
AE0483-G0	TC	13 30 8		106196N	TC	13*30*8
AR0487-E0	VC	13 32 9				
AGG275-A0	VC	14 20 5		112698N	VC	14*20*5
ACC170-A0	SC	14 22 4	A727	100764N	SC	14*22*4
BH3039-E0	HTC	14 22 5.5	B L			
AF0511-F02D6	VB	14 24 4				
ACC239-A0	SC	14 24 5	A727	111596N	SC	14*24*5
AE0512-E02X8	TC	14 24 4.8				
AEE376-B00C0	TC	14 24 6	A727	108535N	TC	14*24*6
ACC731-A0	SC	14 24 7	A727	100923N	SC	14*24*7
AE0515-E11C9	TC	14 24 7		103003N	TC	14*24*7
APP731-A0	TCV	14 24 7	A795	432204N	TCN	14*24*7
ABB731-A00	SB	14 24 7		100645N	SB	14*24*7
AEE485-B00X0	TC	14 25 5	A727	105614N	TC	14*25*5
AEE942-A00	TC	14 25 6				
AEE556-A0	TC	14 25 7		100085N	TC	14*25*7
ADD556-A01	TB	14 25 7		111851N	TZ	14*25*7
BR1119-E04C8	TB5Y	14 25 18	22			
AEE375-A00X0	TC	14 26 7	A727	102645N	TC	14*26*7
BRR741-A0	SB5Y	14 26 12.3				

NOK_NO	NOK			SOG		
	TYPE	SIZE		SOG_NO	TYPE3	PART_NO
BEE032-A00	TC	45 80 8		110905N	TC	45*80*8
AEE750-A0	TC	45 80 10		100609N	TC	45*80*10
AQ8181-P00X7	QLFY	45 85 11	18.8			
BH2416-E0	HTC	46 58 8	B R			
BR5477-E0	DCY	46 58.1 9.5	11.5			
BH2354-G0	HTCY	46 63 7.7	8.5 BR			
BZZ626-A00	Y	46 94.5 8	10			
BCC684-A00	SCY	46 102 10.7	16			
AE7201-E03H8	TC	47 60 7		108488N	TC	47*60*7
AD2763-Y00X6	TB3	47.63 70.6 13.5	*			
BG2039-F0	KCY	47 72.2 6	8 *			
AH2769-E0	HTC	48 60 6	F585			
BH4373-E0	HTC	48 60 7	B R	102755N	TC	48*60*7
BH4373-F0	HTC	48 60 7	F R	102755N	TC	48*60*7
AH8576-E0	HTB	48 60 9	B R	106995N	TB	48*60*9
AF2772-E02X5	VB	48 62 6				
AEE380-A00	TC5Y	48 62 6	9.5			
AEE019-A00	TC	48 62 7		104732N	TC	48*62*7
AAA019-A03	TA2	48 62 7		192998N	TA	48*62*7
AOO019-A01	OKC	48 62 7				
AEE381-A0	TC	48 62 8		440125N	TC	48*62*8
AG2775-Y0	KC3Y	48 62 9	24 *			
	KCY	48 62 9	16			
AE2775-E02L6	TC	48 62 9	A727	106533N	TC	48*62*9
AP2775-G0	TCV	48 62 9				
AP2775-F0	TCV	48 62 9	F			
BBB070-A0	SB2Y	48 62 9				
ADD070-A00	TB2	48 62 9		111066N	TB	48*62*9
AGG063-A01	KCY	48 62 9	25			
BEE476-A02	TCY	48 62 13				
AGG048-A00	KC	48 65 7				
AEE931-A00	TC	48 65 9		105865N	TC	48*65*9
ADD931-A0	TB2	48 65 9		106351N	TB	48*65*9
AH2780-E0	HTB2	48 65 9	B L	106351N	TB	48*65*9
BP4359-E0	TA1Y	48 65 10.3	F			
AD2782-E01X9	TBY	48 66 13				
AEE417-A0	TC	48 68 10		102007N	TC	48*68*10
AH2786-F02L8	HTC	48 68 11	R T599			
AEE004-B0	TC3	48 70 9				
BEE960-A00X0	TC3Y	48 70 9.5	9.8 A571			
ADD004-A00	TB2	48 70 9		104111N	TZ	48*70*9
AEE039-A0	TC	48 70 12		102660N	TC	48*70*12
AP2791-G0	TCN	48 70 12		410300N	TCN1	48*70*12
AD2791-E7	TB	48 70 12		111446N	TB	48*70*12
AEE724-A0	TC	48 72 10		103142N	TC	48*72*10
AEE746-A0	TC	48 74 10		104729N	TC	48*74*10
BCC517-A0	SC	48 80 10		431777N	SC	48*80*10
ADD064-A01	TB	48 80 14		431945N	TB	48*80*14
ADD207-A0	TB2	48 82 12				

NOK_NO	NOK			SOG		
	TYPE	SIZE		SOG_NO	TYPE3	PART_NO
AEE523-A01	TC	14 28 7		100209N	TC	14*28*7
AP0526-G01B4	TCV	14 28 7				
AG8437-E0	VC	14.8 30 5 B				
BCC551-A0	SC	14.8 30 5 T303				
BCC160-A0	SC	14 30 7		102515N	SC	14*30*7
BEE720-A0	TC	14 30 8		102871N	TC	14*30*8
BEE312-A0	TC	14 32 7		104756N	TC	14*32*7
AEE976-B00X0	TCY	14.8 32 7 T303				
BZZ580-A0	Y	14.8 32 7.5 9 B				
AR0561-G04X9	VC	14.5 32 9				
BCC446-A00	SC	15 21 4		111033N	SC	15*21*4
AFF925-A0	VB	15 22 4		105543N	VB	15*22*4
WC0092-A0	SC	15 24 5		101194N	SC	15*24*5
AEE634-A0	TC	15 24 7		100207N	TC	15*24*7
ACC514-A0	SC	15 25 5 A727		102205N	SC	15*25*5
AEE514-A0	TC	15 25 5		103753N	TC	15*25*5
AEE578-A0	TC	15 25 6 A727		105839N	TC	15*25*6
AEE268-B0	TC	15 26 6 A727		107284N	TC	15*26*6
UE0666-E00B6	TC	15 27 7 A727		103393N	TC	15*27*7
ACC444-A0	SC	15 28 7 A727		102227N	SC	15*28*7
AEE444-A0	TC	15 28 7		100210N	TC	15*28*7
BEE464-A0	TC	15 30 5 A727		102808N	TC	15*30*5
AE0598-A0	TC	15 30 7 A3853		102619N	TC	15*30*7
AP0598-A0	TCV	15 30 7				
AP0598-F0	TCV	15 30 7 F				
ADD171-A0	TB2	15 30 7		104208N	TB	15*30*7
ADD619-A00	TB	15 30 8		105305N	TB	15*30*8
AR0600-E10X4	TB4	15 30 10				
AEE308-A0	TC	15 32 7		106530N	TC	15*32*7
UE0760-E0	TC	15 35 6 A795		108870N	TC	15*35*6
AEE464-A02X0	TC	15 35 7 A727		102649N	TC	15*35*7
WF0005-B0	VB	16 22 3 *		105292N	VB	16*22*3
ACC211-A0	SC	16 24 5		100920N	SC	16*24*5
BF0053-E0	KB	16 26 5				
AE0678-F1	TC	16 26 7 A727		102005N	TC	16*26*7
BDD579-A00	TB	16 26 7		109714N	TB	16*26*7
BE2257-E0	TCY	16.85 27 6 7.5				
AR0685-G00X6	SCY	16 28 7				
AEE094-A0	TC	16 28 7 A727		113546N	TC	16*28*7
WP0001-A0	TCV	16 28 7 *		432147N	TCN	16*28*7
BR1153-E0	SBY	16 28 15.2 B				
	SC	16 30 7		108053N	SC	16*30*7
AE0687-A0	TC	16 30 7		100733N	TC	16*30*7
BPP056-A0	TCV	16 30 7 S500				
AD0687-H0	TB	16 30 7		104826N	TB	16*30*7
AR0687-E3	TB4	16 30 7				
AEE336-A0	TC	16 30 8		109313N	TC	16*30*8
BR2219-E0	VCY	16 31 7				
BEE036-A00X0	TC	16 32 7 A727		104207N	TC	16*32*7

NOK_NO	NOK			SOG		
	TYPE	SIZE		SOG_NO	TYPE3	PART_NO
AD2804-E07B9	TB5Y	48 108 9.5				
BE2582-E0	TC3Y	48 109 12.8 14				
BG2034-E02X0	KC5Y	49 64 6 12.5				
BH4165-E0	HTC	49.8 66 8 B R				
BG2038-E00B9	KCY	49 72.2 6 8				
ACC535-A0	SCY	49 99.8 8 9.5				
BRR286-A0	TBL	50 60 7 9		113584N	TZ	50*60*7/9
BDD247-A01	TB2	50 62 7				
	TCY	50 64 8				
AE2834-E00B8	TC	50 64 10		104191N	TC	50*64*10
ABB418-A00	SB2	50 64 10				
WE0019-A0	TC	50 65 8 *		105043N	TC	50*65*8
AH2837-E0	HTC	50 65 8 B R		105043N	TC	50*65*8
AE2838-E0	TC	50 65 9		108645N	TC	50*65*9
ADD042-A00	TB2	50 65 9		431387N	TB	50*65*9
BDD706-A00	TB2	50 65 10		104986N	TB	50*65*10
BEE729-A0	TC9	50 66.5 13 16		420031N	TC9	50*66.5*13/16
AGG084-A00	KC	50 67 9				
ADD084-A00	TB	50 67 9		100238N	TB	50*67*9
AGG096-A0	KC3	50 67 11				
AF8955-E02X0	KBY	50 67 79 14				
BDD608-A0	TB9Y	50 68 7 10				
AQ8270-P02B1	QLNY	50 68 7.5 19				
BEE385-A0	TC	50 68 8		103143N	TC	50*68*8
BP2009-E0	TA1Y	50 68 8.5 F				
AEE050-A0	TC	50 68 9		103077N	TC	50*68*9
AHH050-B0	HTC3	50 68 9 B R				
BHH1132-A0	HTC9	50 68 9 14.5 F585R				
AH2847-S0	HTCK	50 68 9 FB50 R				
AD2847-I1	TB	50 68 9 B		103297N	TZ	50*68*9
AH2847-I0	HTB2	50 68 9 B R		103297N	TZ	50*68*9
AA2847-Y0	TA2	50 68 9 *		193561N	TA	50*68*9
BEE134-A00	TC	50 68 10		100152N	TC	50*68*10
	TC5Y	50 68 10				
AEE951-A00	TC	50 68 12		109818N	TC	50*68*12
BHH568-A00	HTC	50.8 69.85 11 B R				
AA2921-E02B3	SAY	50.8 69.85 11 2.8 C				
ABB033-A04	SB2Y	50 70 9				
BDD1072-A00D0	TB9Y	50 70 9.5 17.5 A103				
AH2853-E0	HSAE	50 70 9				
AEE474-A0	TC	50 70 10		103052N	TC	50*70*10
AH2854-F0	HTC9	50 70 10 16 BR				
	TB3Y	50 70 10				
AAA474-A00	SA2	50 70 10		191676N	SA	50*70*10
AE2857-E01B4	TC	50 70 12		100116N	TC	50*70*12
AD2857-E00C3	TB3	50 70 12 B				
	OVB	50 72 6				
BEE112-A0	TC	50 72 8		101280N	TC	50*72*8
BEE006-A0	TC	50 72 9		104295N	TC	50*72*9

SOG VS NOK

NOK_NO	NOK			SOG		
	TYPE	SIZE		SOG_NO	TYPE3	PART_NO
AE0698-E0	TC	16 35 9		109394N	TC	16*35*9
AB0718-E0	SB1	16.8 35 40 5.5				
ACC943-A00X0	SC	17 25 4 A727		100803N	SC	17*25*4
BEE972-A0	TC	17 27 5 A103		107931N	TC	17*27*5
AG0731-E0	KCD	17 27 10.3				
AEE062-A0	TC	17 28 6 A727		430672N	TC	17*28*6
ADD062-B0	TB	17 28 6		430541N	TM	17*28*6
AEE587-A0	TC	17 28 7		106951N	TC	17*28*7
AHH587-B0	HTC	17 28 7 R T303		106951N	TC	17*28*7
ADD587-A0	TB	17 28 7		104866N	TB	17*28*7
BWW600-A0	DC	17 28 8		107311N	DC	17*28*8
BEE017-C0	TC	17 29 5 A727		102955N	TC	17*29*5
AG0742-E05X2	KC	17 30 6				
AEE038-A0	TC	17 30 6 A727		105444N	TC	17*30*6
	SB2	17 30 6		110784N	TB	17*30*6
AEE542-A0	TC	17 30 7 A727		102536N	TC	17*30*7
APP542-B00B0	TCV	17 30 7 T945				
AZ0744-E0	Y	17 30 7.5 F				
AE0745-H0	TC	17 30 8		105354N	TC	17*30*8
AP0787-E0	TCV	17.46 30.15 8				
AD0745-E1	TB	17 30 8				
BD4084-E0	TBY	17 31 7.9 B				
AEE744-A0	TC	17 32 7		104272N	TC	17*32*7
AD0750-E0	TB	17 32 7		107218N	TB	17*32*7
AEE325-A0	TC	17 32 8 A727		105355N	TC	17*32*8
AW0751-E1	DC	17 32 8				
ACC236-A0	SC	17 34 7		106076N	SC	17*34*7
AD0755-F0	TB	17 34 7				
AE6845-E0	TC	17 34 8				
AD6845-E0	TBY	17 34 8 B				
	VC	17.9 35 5				
AEE290-A00	TC	17 35 7		105654N	TC	17*35*7
WP0003-A0	TCV	17 35 7		432001N	TCN	17*35*7
AEE465-A0	TC	17 35 8 A727		102735N	TC	17*35*8
AP0760-E0	TCV	17 35 8				
AE0761-F0	TC	17 35 10		100485N	TC	17*35*10
AE0768-E0	TC	17 38 7		103751N	TC	17*38*7
AEE442-A1	TC	17 40 8 A727		104921N	TC	17*40*8
UE0667-E0	TC	17 47 8 *		103886N	TC	17*47*8
AF0803-E0	KB	18 26 5				
AEE990-A0	TC	18 28 6		101602N	TC	18*28*6
AEE121-A0	TC	18 28 7 A104		100454N	TC	18*28*7
BDD640-A0	TB	18 28 8				
AE0814-E0	TC	18 30 5		100630N	TC	18*30*5
BEE236-A0	TC	18.9 30 5 A727				
AH0814-E0	HTC	18 30 5 B R		100630N	TC	18*30*5
	Y	18.5 30 4.5				
AE0815-E00X0	TC	18 30 6		105781N	TC	18*30*6
BPP230-A0	TCV	18 30 6 A795				

NOK_NO	NOK			SOG		
	TYPE	SIZE		SOG_NO	TYPE3	PART_NO
BEE520-A00	TC	50 72 10		100439N	TC	50*72*10
AE2864-A06B7	TC	50 72 12 A727		102891N	TC	50*72*12
AE2864-I00X6	TC6	50 72 12				
AP2864-I32B7	TCN	50 72 12		410273N	TCN1	50*72*12
AP2864-J1	TCV	50 72 12 F		480319N	TCN	50*72*12
AD2864-K1	TB	50 72 12		104889N	TB	50*72*12
AR2864-F0	TB4	50 72 12				
GJ2864-H0	SA1J	50 72 12				
AW2864-E0	DC	50 72 12 B				
AD2867-F0	TB2	50 72 14		110482N	TB	50*72*14
AR2867-E0	TB4	50 72 14				
AW2870-H00X7	DB	50 72 18 B		113132N	DB	50*72*18
AA2926-E00D0	TA2	50.8 73.03 15 B				
BZ5001-E01B7	Y	50 74 10 18.9 C				
BHH1188-A0	HTC3	50 74 11 F R				
BEE147-A0	TC	50 80 8		100771N	TC	50*80*8
AEE952-A0	TC	50 80 10		100443N	TC	50*80*10
AE8696-P00X4	TC	50 80 10.5 B				
AEE476-A0	TC	50 80 12		103053N	TC	50*80*12
AAA476-A00	SA2	50 80 12		191476N	SA	50*80*12
AHH396-A00	HTC	50 82 12 R		106496N	TC	50*82*12
AEE920-A00	TC	50 90 10		101547N	TC	50*90*10
BFF282-A00	KB2	51 63 6		104583N	KB	51*63*6
BD2668-E0	TB9	51 63 7.5 10		106902N	TB9	51*63*7.5/10
AEE131-A00	TC	51 65 13				
BDD920-A0	TB9	51.9 66 8 10				
BD4522-F0	TB2	51 75 9 A435				
AF2949-E00D8	VBY	52 62 5 9 B				
ADD929-B00	TBP	52 64 9 B				
AE2955-E0	TC	52 65 9		105029N	TC	52*65*9
ABB013-B01	SB2Y	52 65 9				
ADD013-A00	TB3	52 65 9				
BDD1339-A0	TB9	52 66 7.5 12.1				
BD3534-F0	TBW	52 66 7.5 12.2				
BOO738-A0	OTBY	52 67 6.7 8.7				
BFF055-A0	KB9	52 68 7 13		103638N	KB9	52*68*7/13
BDD1385-A0	TBW	52 68 7.5 12.1				
BCC127-A00	SC	52 68 8		101118N	SC	52*68*8
BE1778-E0	TCY	52 68 13				
BOO485-A0	OTC	52 70 7.5				
AEE141-A0	TC	52 70 9		104752N	TC	52*70*9
ADD141-B00X0	TB	52 70 9 A435		104025N	TB	52*70*9
AHH141-A01	HTBW	52 70 9 15 B L				
BDD669-A00	TB3	52 72 8				
ADD189-A00	TB2	52 72 13				
BD1360-E0	TB2	52 73 10		109734N	TB	52*73*10
AE2965-F11C9	TC	52 75 9		111011N	TC	52*75*9
AP2965-F0	TCN	52 75 9				
AP2965-E01X0	TCN	52 75 9 F624				

NOK_NO	NOK			SOG		
	TYPE	SIZE		SOG_NO	TYPE3	PART_NO
BP1134-E0	TCL	18 30	6.4 7			
BEE409-A0	TC	18 30	7 A727	102650N	TC	18*30*7
AH0816-E0	HTC	18 30	7 B R	102650N	TC	18*30*7
AEE991-A0	TC	18 30	8	105829N	TC	18*30*8
AD0817-E0	TB	18 30	8	111681N	TB	18*30*8
BRR936-A0	DCY	18 30	10 15			
BEE116-A0	TC	18 31	7	105342N	TC	18*31*7
AEE466-A0	TC	18 32	7	102537N	TC	18*32*7
UP0913-E0	TBV	18 32	7.9			
AR0848-H06B9	VC	18.5 32	9			
AR7034-E7	VB	18.5 32	10.9			
ARR589-A0	DCY	18 32	10 15			
BR1442-E0	TCD	18 32	38 13.2 B			
BH4243-E0	HTC	18 33	6 F L			
BDD1064-A0	TBY	18 34	7.9 B			
AE0828-P0	TC	18 35	7	100088N	TC	18*35*7
AEE467-A0	TC	18 35	8	106126N	TC	18*35*8
APP467-A0	TCV	18 35	8	431417N	TCN	18*35*8
AE0831-E0	TC	18 35	9			
BEE700-A00	TCY	18 37	7			
AE0838-E0	TC	18 38	7	108593N	TC	18*38*7
BEE809-A0	TC	19 30	5 T599			
AE7094-E0	TC	19 30	7	111266N	TC	19*30*7
AE0864-FO	TC	19 30	8	106201N	TC	19*30*8
AB0864-E0	SB	19 30	8			
	KC	19 32	5			
AEE285-A0	TC	19 32	5 A727	108322N	TC	19*32*5
AEE944-A0	TC	19 32	7	103348N	TC	19*32*7
AP8096-E0	TCL	19 32	7 8	432164N	TC	19*32*7/8
AEE272-A01X0	TC	19 32	8 A727	103737N	TC	19*32*8
ADD272-A00	TB2	19 32	8			
BP1503-E0	TCL	19.05 34.6	6.3 7.3			
AE0874-E1	TC	19 35	7	100386N	TC	19*35*7
BEE977-A0	TC	19 35	8 A727	112400N	TC	19*35*8
AP0875-E0	TCV	19 35	8			
AE0880-E0	TC	19 38	7	105294N	TC	19*38*7
BP2152-E0	TCL	19 38	7 7.8			
AF0962-I0	KB	20 26	4			
AF0973-F02B4	VB	20 28	4	100288N	VB	20*28*4
WE0105-A0	TC	20 28	4	105445N	TC	20*28*4
BCC093-A0	SC	20 28	6	103411N	SC	20*28*6
ACC126-A0	SC	20 30	5 A727	104251N	SC	20*30*5
AEE126-A0	TC	20 30	5 *	401212N	TC	20*30*5
BPP215-A00X0	TCV	20 30	4.5 A795			
AEE714-A00X0	TC	20 30	6 A727	106805N	TC	20*30*6
ADD714-B0	TB	20 30	6 B	103594N	TZ	20*30*6
AD0982-M0	TBY	20 30	6 B			
UE0673-E0	TC	20 30	7 A727	102651N	TC	20*30*7
ADD035-B0	TB	20 30	7	102978N	TB	20*30*7

NOK_NO	NOK			SOG		
	TYPE	SIZE		SOG_NO	TYPE3	PART_NO
BEE007-A00	TC	52 75	12	103666N	TC	52*75*12
AP2967-F0	TCV	52 75	12			
AD2967-G1	TB	52 75	12	108232N	TB	52*75*12
AQ2967-E0	QLNY	52 75	12 18			
ADD115-A00	TB2	52 75	13			
BDD1104-A0	TB2Y	52 76	11 12 A435			
	KB	52 82	7			
AHH374-A03	HTB2	52 84	14 R			
AQ7747-E0	QLNY	52 85	16.5 19			
AEE407-A00	TC5	52 100	15			
AH2977-E0	HTCS	52 100	15 20.75 BR			
BDD170-A00	TB	53 65	13			
BH4852-E0	HTCK	53 69.85	11 (FB50)R			
XD0383-E0	TB9Y	53 69	11 18.9			
BG8035-E0	KC5Y	54 64	9 24			
BD5668-E0	TB9Y	54 65	7.7 14.7			
BDD094-A01	TB	54 65	13	104113N	TZ	54*65*13
BD3236-E03X7	TB9	54 66	7.5 10	103284N	TB9	54*66*7.5/10
BDD207-A01	TB2	54 72.5	9	104117N	TZ	54*72.5*9
BEE221-A0	TC	54 72	10	401358N	TC	54*72*10
AB3014-E11X9	SB	54 72	12	107928N	SB	54*72*12
BEE1298-A03X0	TC9Y	54 75.7	12.2 17.9A10			
BEE269-A0	TC	54 76	8	108622N	TC	54*76*8
BDD921-A0	TB9Y	54 76	8 11			
BEE264-A00	TC	54 76	10			
BD4376-E0	TB9Y	55 68	6.5 11.8			
BEE222-A00	TC	55 70	8	101040N	TC	55*70*8
AE3036-E1	TC	55 70	9	107078N	TC	55*70*9
AD3036-F1	TB	55 70	9			
BEE882-A0	TC	55 72	8	100460N	TC	55*72*8
AH7316-F0	HTBW	55 72	9 15 A L			
AE3040-A03M8	TC	55 72	9 A727	105059N	TC	55*72*9
AH3040-H0	HTC	55 72	9 R T599	105059N	TC	55*72*9
ADD392-A02	TB2	55 72	9	106111N	TB	55*72*9
AH3040-G0	HTB2	55 72	9 B R	106111N	TB	55*72*9
AH7316-E0	HTBW	55 72	9 15 B L			
BEE131-A0	TC	55 72	10	100535N	TC	55*72*10
AE3042-E01X2	TC	55 72	12	106815N	TC	55*72*12
AFF718-A00	KB2	55 72	14.8			
AEE475-A0	TC	55 75	9	107280N	TC	55*75*9
ACC734-A01	SC	55 75	10	103667N	SC	55*75*10
BEE630-A00	TC	55 75	12 B	103253N	TC	55*75*12
UP0803-E01X0	TCN	55 75	12 F624			
BH3275-E0	HTC	55 77	8.5 B R			
AE3053-E0	TC	55 78	9	111326N	TC	55*78*9
AE3055-A0	TC	55 78	12 A727	103823N	TC	55*78*12
AEE399-B00	TC3	55 78	12 B			
AP3055-G10B8	TCV	55 78	12	480320N	TCN	55*78*12
AP3055-F3	TCN	55 78	12	410274N	TCN1	55*78*12

SOG VS NOK

NOK_NO	NOK			SOG		
	TYPE	SIZE		SOG_NO	TYPE3	PART_NO
AR0984-F0	TB4	20 30 7				
AEE986-A0	TC	20 30 9	108368N	TC	20*30*9	
AE8250-P00B9	TC	20 31 7	103930N	TC	20*31*7	
BDD560-A0	TB	20 31 7	410197N	TZ	20*31*7	
AH0994-E0	HTC	20 32 5 B R	107348N	TC	20*32*5	
AE0995-J0	TCY	20 32 6 F				
ABB557-A00	SB2	20 32 6	113937N	SB	20*32*6	
AEE283-A00X0	TC	20 32 7 A727	102715N	TC	20*32*7	
AD0996-F00C6	TB	20 32 7 B	104976N	TB	20*32*7	
AP8027-E0	TCL	20 32.5 7 7.6 *				
AE8027-E01B7	TCL	20 32.5 7 7.6				
AEE966-A0	TC	20 32 8 A727	109248N	TC	20*32*8	
AD0997-H14D7	TB	20 32 8	111131N	TB	20*32*8	
ARR590-A0	DCY	20 32 10 15				
AW8679-E0	DC	20 34 8 B				
ARR536-A0	DCY	20 34 10 15				
AE1010-G0	TC	20 35 6	102942N	TC	20*35*6	
AEE060-A0	TC	20 35 7 A727	102652N	TC	20*35*7	
AP1012-J0	TCV	20 35 7 B				
ADD060-A0	TB2	20 35 7	103342N	TB	20*35*7	
AE1013-A03D9	TC	20 35 8 A103	101207N	TC	20*35*8	
AD1013-E0	TB2	20 35 8	112366N	TB	20*35*8	
AEE967-A0	TC	20 35 10	104844N	TC	20*35*10	
AD1015-F0	TB2	20 35 10	113188N	TB	20*35*10	
AP1015-E00X8	DCY	20 35 10 B				
AEE992-A00X0	TC	20 36 7 A727	105376N	TC	20*36*7	
AP1017-F0	TCV	20 36 7				
AEE582-B0	TCY	20 37 8 A727				
AEE484-A0	TC	20 38 5 A727	105840N	TC	20*38*5	
AEE468-A0	TC	20 38 7	103394N	TC	20*38*7	
	SC	20 40 6	432012N	SC	20*40*6	
AEE293-A0	TC	20 40 6 A727	106482N	TC	20*40*6	
AE1029-E20L1	TC	20 40 7 A727	102653N	TC	20*40*7	
APP555-A01X0	TCV	20 40 7 A727				
AE1032-H0	TC	20 40 10 A727	100089N	TC	20*40*10	
AD1032-F02C0	TB2	20 40 10	105961N	TB	20*40*10	
AD1032-E3	TB	20 40 10 B	105961N	TB	20*40*10	
AEE993-A0	TC	20 40 11 A727	110568N	TC	20*40*11	
AP1033-A0	TCV	20 40 11	115045N	TCN	20*40*11	
AP1033-I0	TCN	20 40 11				
AD1033-F02X1	TB2	20 40 11				
BW0092-E00X7	DB	20 40 14	410227N	DB	20*40*14	
BRR1180-A0	DCY	20 41.6 3.6 13.6				
AEE617-A01X0	TC	20 42 7 A727	103004N	TC	20*42*7	
AEE994-A00X0	TC	20 42 8 A727	108779N	TC	20*42*8	
AC1038-E02L3	SC	20 42 10 A727	101515N	SC	20*42*10	
BEE273-A0	TC	20 45 8 A727	105200N	TC	20*45*8	
AB1045-E03X2	SB2	20 45 12				
	SC5Y	20.42 46.8 6.4				

NOK_NO	NOK			SOG		
	TYPE	SIZE		SOG_NO	TYPE3	PART_NO
AR3055-E20X6	TB4	55 78 12				
AD3055-E0	TBY	55 78 12				
AP3055-P0	TCN	55 78 12 F624				
AW3055-G0	DCY	55 78 12 F				
BCC827-A0	SC	55 80 8				
WE0079-A0	TC	55 80 8				
AE3061-E01B4	TC	55 80 10				
AC3062-E0	SC	55 80 12				
AB3062-E03X9	SB	55 80 12				
AR3063-E0	TB4	55 80 14				
BCC525-A0	SC	55 85 8				
AC3072-E0	SC	55 85 14				
	TA	55 86 13				
BEE216-A0	TC	55 90 10				
AQ3078-E02X4	QLFY	55 92 15.5 24				
AF3088-E01X5	VB2	56 70 6				
AE3090-E01C9	TC	56 70 9				
BD2667-E0	TBW	56 71 7 11.5				
BD2332-G03X1	TB9Y	56 72 6.5 11.5				
BCC463-A00	SC	56 72 8				
AE3092-E0	TC	56 72 9				
BEE486-A00	TCY	56 72 12.5				
BD3277-H0	TB9Y	56 73 7.5 14.8				
BDD1331-A0	TBW	56 73 8 12.5				
BD4374-E0	TB9Y	56 74.2 6.5 10.5				
BDD1387-A0	TBW	56 75 8 12.5				
AE3094-E00X8	TC	56 78 12				
AZZ284-A02	Y	56 99.4 8				
BA3742-E00X5	TA9Y	56 99 10 34.5 B				
AB7891-E0	SB	57.12 67 5.5				
AE3103-E01B1	TC	57 67 6 A727				
AE7450-E0	TC8	57 75 12				
BA0379-E00X2	SA2	57.15 76.33 12.7				
AH7143-F0	HTC	57 77 10 C L				
AA9157-E00X4	SA2	57.15 79.5 12.7				
AQ3108-E04X2	QLNY	57 80 12 18				
BBB284-A00	SB2	57 85 12				
ACC717-A00	SCY	57 122 8 10.5				
BE2323-E0	TC3Y	57 124 12.7 14				
AE3144-E1	TC	58 72 9				
AHH654-B00	HTC	58 74 10 L				
AF3147-E03X9	VB2	58 75 7				
BE2727-E0	TC9Y	58 75 7.5 11.5				
AEE989-A00	TC	58 75 9				
AH3148-E01D9	HTC3	58 75 9 B R				
AH3148-P01C3	HTC9	58 75 9 14.5 BR				
AE7419-E00B0	TC	58 75 12 B				
BEE833-A00	TC	58 80 8				
AE3152-E03C4	TC	58 80 9				
106792N	TZ	55*78*12				
410274N	TCN1	55*78*12				
480369N	DC	55*78*12				
101619N	SC	55*80*8				
103055N	TC	55*80*8				
100105N	TC	55*80*10				
101199N	SC	55*80*12				
108826N	TB	55*80*12				
100586N	SC	55*85*8				
112125N	SC	55*85*14				
101548N	TC	55*90*10				
106829N	TC	56*70*9				
102391N	SC	56*72*8				
109871N	TC	56*72*9				
110109N	TC	57*67*6				
103644N	SB	57*85*12				
104852N	TC	58*72*9				
112079N	TC	58*74*10				
105281N	TC	58*75*9				
103525N	TC	58*75*12				
102443N	TC	58*80*8				
104982N	TC	58*80*9				

NOK_NO	NOK			SOG		
	TYPE	SIZE		SOG_NO	TYPE3	PART_NO
ACC614-A00	SC	20 47 7		100721N	SC	20*47*7
AEE614-A0	TC	20 47 7 A727		102718N	TC	20*47*7
WE0067-A0	TC	20 47 8		401220N	TC	20*47*8
AEE494-A00	TC	20 47 10		100223N	TC	20*47*10
ACC370-A0	SC	20 52 8 A727		105841N	SC	20*52*8
AEE370-A0	TC	20 52 8		105841N	TC	20*52*8
BDS1434-A0	TB	21 32 6 B				
AD1082-F01X6	TB	21 32 8 B				
BP5244-E0	TCL	21 33 7 7.9				
	VB	21 35 6				
BCC240-A00X0	SC	21 35 7 A727		107792N	SC	21*35*7
AE1089-E01X9	TC	21 38 8				
BEE647-A01X0	TC	21 40 7 A103		104096N	TC	21*40*7
AF1103-F0	VB	22 28 4		115174N	VB	22*28*4
AG1108-E0	VC	22 30 4				
AEE945-A01	TC	22 32 5		102656N	TC	22*32*5
BBB218-A00	SB	22 32 5.5				
BEE241-A0	TC	22 32 6 A727		106047N	TC	22*32*6
WE0097-A0	TC	22 32 7		102678N	TC	22*32*7
AD1116-E10B4	TB	22 32 7		103240N	TB	22*32*7
ACC079-A0	SC	22 32 8 A727		106411N	SC	22*32*8
BEE999-A0	TC	22 33 7		108337N	TC	22*33*7
BPP625-A00	TCL	22 34 6.5 7.1				
BP2094-E0	SCJY	22 34 8.5				
BRR674-A0	DCY	22 34 10 14				
AEE577-A00X0	TC	22 35 6 A727		104845N	TC	22*35*6
AEE372-A0	TC	22 35 7 A727		102538N	TC	22*35*7
AEE288-A0	TC	22 35 8 A727		104019N	TC	22*35*8
ARR288-A00X0	TC4	22 35 8 A400				
AP1127-E1	TCV	22 35 8				
AD1127-E0	TB2	22 35 8		410156N	TB	22*35*8
AD1128-E0	TB4	22 35 10				
AEE978-A0	TC	22 36 7		103630N	TC	22*36*7
BP0105-F0	TCV	22 36 7				
AP1130-F0	TCV	22 36 10				
AP1130-E0	TCNY	22 36 10				
ARR440-A0	DCY	22 36 10 15				
AC1131-E01X3	SC	22 37 8				
AE1132-E00B8	TC	22 38 6		110328N	TC	22*38*6
AEE995-A0	TC	22 38 8		104257N	TC	22*38*8
AP6826-E0	TCV	22.15 38.02 8				
AD1133-F11B1	TB	22 38 8				
AD1165-E02C0	TB4Y	22.14 38 9.5				
ACC630-A01X0	SC	22 40 7 A727		101322N	SC	22*40*7
BEE627-A0	TC	22 40 8		101573N	TC	22*40*8
BEE870-A0	TC	22 40 11 A727				
AD6710-E0	TB2	22 41.25 7				
AE1145-E0	TC	22 42 7		105109N	TC	22*42*7
AD1147-H1	TB	22 42 10		111329N	TB	22*42*10

NOK_NO	NOK			SOG		
	TYPE	SIZE		SOG_NO	TYPE3	PART_NO
ACC733-A0	SC	58 80 10		101360N	SC	58*80*10
AHH733-A00	HTC	58 80 10 R		103145N	TC	58*80*10
BEE554-A0	TC	58 80 12		101288N	TC	58*80*12
AE3154-L00B1	TC5	58 80 12				
AP3154-H0	TCN	58 80 12				
BHH554-A00	HTC5	58 80 12 B R				
AD3154-F0	TB2	58 80 12		104890N	TB	58*80*12
AE3159-E01X1	TC	58 90 11		103362N	TC	58*90*11
	OBY	58 92 10				
BH2583-E01B4	HTAWY	58 102 8 22 B X				
BH1828-E0	HTB2	58 102 9 R				
BH6215-E0	HTC9	58 102 11 19.5 BX				
BH3040-E0	HTBW	58 103 11 19 B R				
AEE728-A00	TC9	58 103 12 19.5 B				
BHH238-A00	HTB2	58 102 12 R				
XD0392-E0	TBW	59 75 9 12.65				
BDD089-A0	TB2	60 72 7.5		105046N	TB	60*72*7.5
BDD614-A00	TB3	60 72 12				
AB3185-E1	SB	60 72 18				
AD3186-E1	TB3	60 74 7.5				
BDD947-A00X0	TB9Y	60 75 5.8 11.8 A103				
BCC178-A00	SC	60 75 8		100988N	SC	60*75*8
BEE008-A00	TC	60 75 9		107155N	TC	60*75*9
AD3193-F0	TB	60 75 9		109654N	TB	60*75*9
BH0400-E0	HTB9	60 75 9 15 BL				
BH5434-E0	HTC	60 76 7 (FB50)L				
XH0262-E0	HTC	60.5 77.35 8 F585J				
ADD086-A0	TB2	60 77 12		101895N	TZ	60*77*12
AF3203-G03B9	VB2	60 78 7		106763N	VB	60*78*7
AP3204-G00B7	TCV	60 78 9				
AD3204-F03B9	TB2	60 78 9		113355N	TB	60*78*9
AD3205-F0	TBP	60 78 10 B				
AA9131-E00C6	SA2	60.32 79.5 12.7				
ACC656-A0	SC	60 80 8		100772N	SC	60*80*8
AEE647-A03X0	TC	60 80 8 S500		100338N	TC	60*80*8
AHH656-B0	HTC	60 80 8 L S708		100338N	TC	60*80*8
AEE699-A00	TC	60 80 10		104147N	TC	60*80*10
AE3213-E5	TC	60 80 12		104051N	TC	60*80*12
AD3213-F02B0	TB2	60 80 12		103063N	TB	60*80*12
BBB366-A00	SB2	60 80 13		101291N	SB	60*80*13
AGG527-A00	KC	60 82 7				
AH3220-F72YY	HTC	60 82 9 B L TH		101523N	TC	60*82*9
AH3221-E0	HTCK	60 82 10 B R				
AEE390-A0	TC	60 82 12		104597N	TC	60*82*12
AE3222-P00E2	TC	60 82 12 B		104597N	TC	60*82*12
AP3222-G01X1	TCV	60 82 12				
AH3222-P1	HTC	60 82 12 R T599		104597N	TC	60*82*12
AP3222-B6	TCN	60 82 12		410018N	TCN1	60*82*12
AH3222-F0	HTCK	60 82 12 B R				

SOG VS NOK

NOK_NO	NOK			SOG		
	TYPE	SIZE		SOG_NO	TYPE3	PART_NO
AR1147-F0	TB4	22 42 10 B				
AP1148-E0	TCV	22 42 11				
AP1148-F0	TCN	22 42 11				
AO1156-E01X4	OVB2	22 45 8.5				
BRR1077-A0	DCY	22 47.4 3.6 13.6A437				
AE7438-E00B5	TC	22 47 8				
BG3657-E0	VC	23 31.8 5.5				
BPP666-A01X0	SCJY	23.5 33.5 6 G418				
BP2151-E0	SCY	23 34 6.5				
BHH815-A0	HTC	23 34 8 L A727				
AE1215-E0	TC	23 35 6	108740N	TC	23*35*6	
AE1217-E0	TC3	23 35 10				
BP1686-E0	SCJY	23 37 9	114718Y	SCJY	23*37*9	
BP1501-G0	SCJY	23.02 38.1 8.2				
AH7235-E00B7	HTC	23 40 7 B L	108738N	TC	23*40*7	
AEE287-A00	TC	23 42 7				
AEE545-A0	TC	23 47 8	106298N	TC	23*47*8	
BDD037-A0	TB	24 34 7				
BP2267-F0	SCJY	24 34 7	470068Y	SCJY	24*34*7	
ACC932-A0	SC	24 35 6 A727				
ABB584-A01	SB2	24 35 7	111134N	SB	24*35*7	
AE1245-E0	TC	24 35 8	104047N	TC	24*35*8	
AD8851-E0	TB	24 36 6 B				
AP8097-E0	TCY	24 36 7 8				
AP8097-H0	TCL	24 36 7 7.4				
AP8097-G02X3	SCJY	24 36 7	470054Y	SCJY	24*36*7	
BP1569-F0	SCJY	24 36 8				
AE1252-E0	TC	24 38 8	101080N	TC	24*38*8	
BP1829-G0	SCJY	24 38.2 8.5	470070Y	SCJY	24*38.2*8.5	
AE1259-H01	TC	24 40 7 A727	102716N	TC	24*40*7	
BPP534-A0	TCV	24 40 7				
AE1260-A01L7	TC	24 40 8 A727	103206N	TC	24*40*8	
AP1260-E0	TCV	24 40 8				
AHH025-B0	HTC	24 40 8 R	103206N	TC	24*40*8	
AH1260-E02C2	HTC	24 40 8 B R	103206N	TC	24*40*8	
AP1260-O0	SCJY	24 40 8	470072Y	SCJY	24*40*8	
BPP728-A0	SCJY	24 41 8.5 G418	470074Y	SCJY	24*41*8.5	
ACC946-A00	SC	24 42 8	380006N	SC	24*42*8	
BP2285-E0	SCJY	24 42 8.5	470075Y	SCJY	24*42*8.5	
BP3050-F0	SCJY	24 43 7	470056Y	SCJY	24*43*7	
AP8916-E0	TBY	24 43 8.8 B				
BP3525-E0	SCJY	24.99 43 9				
AD1266-F0	TB2	24 45 10	110639N	TB	24*45*10	
AD1271-E00B7	TB	24 48 11				
AP8725-E0	TCV	24.61 53.98 7				
AF1400-E0	VB	25.4 31.85 3.18				
BFF474-A0	VB	25 32 4	100006N	VB	25*32*4	
ACC638-A0	SC	25 33 6 A727	106104N	SC	25*33*6	
UE0205-E0	TC	25 33 7 *				

NOK_NO	NOK			SOG		
	TYPE	SIZE		SOG_NO	TYPE3	PART_NO
ADD390-A0	TB2	60 82 12				
AD3222-S1	TB	60 82 12 B				
AR3222-E70B2	TB4	60 82 12				
AD3222-M00C8	TBY	60 82 12 18.5				
AP3222-H32X8	TCN	60 82 12 F624	410018N	TCN1	60*82*12	
AR3224-E03B6	TB4	60 82 14				
AEE988-A00	TC	60 85 8	103056N	TC	60*85*8	
AEE930-A0	TC	60 85 10	100158N	TC	60*85*10	
AAA930-A00	SA2	60 85 10	191186N	SA	60*85*10	
AAA761-A00	TA2	60.32 85.09 11.9				
AE3234-F0	TC	60 85 12	104316N	TC	60*85*12	
AH8784-E01C5	HTBW	60 88 9.5 16.5BL				
BEE111-A0	TC	60 90 8	104014N	TC	60*90*8	
BCC235-A0	TC	60 90 10	102954N	TC	60*90*10	
AEE329-A0	TC	60 90 11	104923N	TC	60*90*11	
AA3268-F01X9	SA2	60.32 92.15 12.7				
BEE148-A0	TC	60 95 10	100167N	TC	60*95*10	
AA8390-E0	TA9Y	60 103 10 34.5 B				
AE7704-E0	TC9Y	60 114 12.5 29 B				
BDD629-A0	TBW	60 103 12 20 B				
AE7296-E0	TC	60 100 15 B				
XD0132-E0	TBW	61 78 7 9.8				
AD3283-F0	TBY	62 75 6 9.5				
BF1868-E00X9	KBW	62 78 7 9.5				
AE3290-E3	TC	62 80 9	103375N	TC	62*80*9	
AD3290-F0	TB2	62 80 9 B	102237N	TB	62*80*9	
ADD397-A00	TB2	62 85 8	101887N	TB	62*85*8	
AAA397-A02	TA2Y	62 85 8 10	191887N	TA	62*85*8/10	
BEE631-A0	TC	62 85 9	113380N	TC	62*85*9	
BEE297-A0	TC	62 85 10	100199N	TC	62*85*10	
AE3297-G03D7	TC	62 85 12 B	105146N	TC	62*85*12	
AE3297-E1	TC	62 85 12 F	105146N	TC	62*85*12	
AP3297-G0	TCN	62 85 12	410301N	TCN1	62*85*12	
UD0172-E00B7	TB2	62 85 12 *	115332N	TB	62*85*12	
BDD091-A0	TB	62 85 12 B	115332N	TB	62*85*12	
AE3299-E01D9	TCCY	62 85 13 13.5 B				
AW3302-E1	DB2	62 85 18	108817N	DB	62*85*18	
BH4354-E0	HTB9	63 78 9 15 B L				
AEE726-A00	TC	63.5 85 12	111366N	TC	63.5*85*12	
AA3362-E03B6	SA2Y	63.55 93.98 14.27 C				
AE3324-E0	TCC	63 100 12 B				
BH1488-E0	HTCS	63 100 12.5 21.3BR				
ACC563-A00	SC	64 80 8	106016N	SC	64*80*8	
AEE078-A02	TC3Y	64 133 13				
BHH1133-A0	HTC	65 79 7 F585J				
ACC609-A00	SC	65 80 8	102233N	SC	65*80*8	
AH7311-E0	HTB9	65 80 10 17.3 BL				
BDD948-A0	TB9Y	65 82 7 13.5 A103				
BHH635-A01	HTC	65 84 9 B R	111076N	TC	65*84*9	

NOK_NO	NOK			SOG		
	TYPE	SIZE		SOG_NO	TYPE3	PART_NO
BEE257-A00	TC	25 34 7		114121N	TC	25*34*7
AD1289-E1	TB	25 34 7		113496N	TB	25*34*7
AEE513-A0	TC	25 35 5		106806N	TC	25*35*5
AEE144-A0	TC	25 35 6 A727		103759N	TC	25*35*6
APP144-A0	TCV	25 35 6 A795		431263N	TCN	25*35*6
AHH144-A00X0	HTC	25 35 6 R T599		103759N	TC	25*35*6
AH1292-J0	HTC	25 35 6 F R		103759N	TC	25*35*6
ABB144-A00	SB	25 35 6				
AEE059-A0	TC	25 35 7		100004N	TC	25*35*7
AHH059-A0	HTC	25 35 7 R A727		100004N	TC	25*35*7
ADD059-A0	TB	25 35 7		104757N	TZ	25*35*7
AE1295-E0	TC	25 35 8		105850N	TC	25*35*8
AP1295-G0	SCJY	25 35 8		470200Y	SCJY	25*35*8
AEE643-A0	TC	25 36 7 A727		100389N	TC	25*36*7
AEE756-A0	TC	25 36 9		107815N	TC	25*36*9
BEE015-A00X0	TC	25 37 6 A727		100390N	TC	25*37*6
WC0081-A0	SC	25 37 7		101227N	SC	25*37*7
AEE338-A0	TC	25 37 8		106199N	TC	25*37*8
AH1302-F0	HTC	25 37 8 R		106199N	TC	25*37*8
BEE548-A0	TC	25 38 5 A727		102533N	TC	25*38*5
AEE001-A02X0	TC3	25 38 7 A727				
AE1306-G01X3	TC4	25 38 7				
AP1306-F0	TCV	25 38 7				
ADD001-A00	TB2	25 38 7		103343N	TB	25*38*7
AP1306-H0	TCL	25 38 7 7.8		432165N	TC	25*38*7/7.8
BEE126-A00X0	TC	25 38 8 A727		107403N	TC	25*38*8
BP1713-F0	SCJY	25.5 38.5 8				
AP8884-P0	TCNY	25 38 9				
AR1309-F01B9	TC4	25 38 10				
BCC203-A0	SC	25 40 5 A727		102316N	SC	25*40*5
BEE853-A0	TC	25 40 6 A795		106616N	TC	25*40*6
AE1313-E0	TC	25 40 7 A103		102539N	TC	25*40*7
AE1313-H0	TCY	25 40 7 8.5				
AEE129-A0	TC	25 40 8 A727		100045N	TC	25*40*8
AP1314-H0	TCV	25 40 8				
AHH129-A0	HTC	25 40 8 R A727		100045N	TC	25*40*8
ADD129-A00	TB2	25 40 8		105207N	TB	25*40*8
AWW129-A0	DC	25 40 8 A727		100117N	DC	25*40*8
AEE576-A00X0	TC	25 40 9 A727		105699N	TC	25*40*9
AE1315-F0	TC	25 40 10		100092N	TC	25*40*10
AB1315-E03X6	SB2	25 40 10		101247N	SB	25*40*10
AP1315-F0	DCY	25 40 10		104868N	DC	25*40*10
AEE685-A0	TC	25 41.25 6 A727		111220N	TC	25*41.25*6
ADD487-A00	TB	25 41.2 7				
AE1318-F00M8	TC	25 41.2 8 T599				
AE1318-E00C5	TC	25 41.2 8				
BP4845-E	SCJY	25.5 41 8.5				
AEE056-A01X0	TC	25 41.55 10 A727		401229N	TC	25*41.55*10
AEE522-A0	TC	25 42 7		103134N	TC	25*42*7

NOK_NO	NOK			SOG		
	TYPE	SIZE		SOG_NO	TYPE3	PART_NO
AH8291-Q00B4	HTC	65 84 9 C R		111076N	TC	65*84*9
AH8291-E00X1	HTCK	65 84 9 B L				
BEE034-A00	TC	65 84 10				
AEE091-A0	TC	65 85 10		106531N	TC	65*85*10
ADD091-A0	TB2	65 85 10		400816N	TB	65*85*10
AEE477-A0	TC	65 85 12		101339N	TC	65*85*12
AH3399-F0	HTC	65 88 9 B L				
AEE447-A0	TC	65 88 12		101217N	TC	65*88*12
BHH462-A0	HTC9	65 88 12 19 BR				
AD3400-K03B4	TB	65 88 12 B		113392N	TB	65*88*12
ADD408-A01	TB2	65 88 13				
BEE023-A0	TC	65 90 10		103057N	TC	65*90*10
AE3409-A02X4	TC	65 90 13 A727		410014N	TC	65*90*13
AE3409-P0	TC	65 90 13 B		410014N	TC	65*90*13
AP3409-F4	TCN	65 90 13		410019N	TCN1	65*90*13
BDD1305-A0	TB2	65 90 13		100036N	TB	65*90*13
AP3409-H1	TCN	65 90 13 F624		410019N	TCN1	65*90*13
BW0450-E40X3	DB	65 90 20		109024N	DB	65*90*20
AH7167-E0	HTBW	65 95 14 20.5 BL				
AE3414-P0	TC	65 95 14 B		107364N	TC	65*95*14
ADD139-A0	TB2	65 95 14				
AD3414-I0	TB	65 95 14 B				
ARR139-A00	TB4	65 95 14				
AH3414-E02C9	HTBW	65 95 14 22 B R				
BEE213-A0	TC	65 100 9.5		108644N	TC	65*100*9.5
BH6132-E0	HTB9Y	65 114 9 25 B R				
AEE749-A00	TC	65 120 10		107959N	TC	65*120*10
BH2023-E03C8	HTAWY	65 114 10 26 B R				
AOB073-A0	OBV	65 120.5 10				
AE3419-E0	TC	65 100 12 B		101832N	TC	65*100*12
AQ7984-P0	QLNY	65 100 17 19				
BA2990-F0	TA2Y	68 85 8 10		194999N	TA	68*85*8/10
AA9133-E00C0	SA2	66.68 98.58 11.9				
BES638-A0	TC3Y	66 134 15.8 17 B				
BHH515-A0	HTC	68 86 8 L S708		109501N	TC	68*86*8
BH2820-E04X6	HSC	68 88 8 B				
AA8355-E03X4	TA2	68 88 9.5		420026N	TA	68*88*9.5
ADD181-A00	TB2	68 88 10		100108N	TB	68*88*10
BEE266-A0	TC	68 90 10		440045N	TC	68*90*10
BH1831-E0	HTBW	68 90 10 18 BL				
BAA266-A0	TAP	68 90 10				
AEE040-A0	TC	68 90 12		102877N	TC	68*90*12
ADD040-A00	TB2	68 90 12		105663N	TB	68*90*12
AAA040-B0	TAP	68 90 12				
AP3461-G0	TCN	68 90 14				
ADD234-A0	TB2	68 92 12		110674N	TB	68*92*12
AD3463-E7	TB2	68 95 13		103226N	TB	68*95*13
AHH740-A02	HTBWY	68 124 11.5 27 BR				
AR6834-E00B1	TB4	69.85 82.55 12.5				

SOG VS NOK

NOK_NO	NOK			SOG		
	TYPE	SIZE		SOG_NO	TYPE3	PART_NO
AE1322-F0	TC	25 42 8	A727	105006N	TC	25*42*8
BEE845-A0	TCY	25.4 42 8	A727			
BP3763-F0	SCJY	25.5 42.5 8		470059Y	SCJY	25.5*42.5*8
BP2392-F0	SCJY	25.5 42 9				
AEE294-A0	TC	25 42 10	A727	102953N	TC	25*42*10
AEE997-A0	TC	25 42 11	A727			
BP4927-F0	SCJY	25.5 42.5 8.5				
BEE695-A00	TC	25 44 8		101083N	TC	25*44*8
BP3284-G0	SCJY	25.5 44 8.5		470060Y	SCJY	25.5*44*8.5
AD1334-E02B9	TB2	25 45 7				
AC1335-E01L8	SC	25 45 8	A727	103768N	SC	25*45*8
BDD628-A0	TB2	25 45 8				
AH1335-E0	HTB	25 45 8	B L			
AEE449-A0	TC	25 45 10		104831N	TC	25*45*10
ADD449-A00	TB2	25 45 10		100392N	TB	25*45*10
AR1337-E01B5	TB4	25 45 10				
AEE081-A0	TC	25 45 11	A727	100780N	TC	25*45*11
AP1338-A0	TCV	25 45 11		113002N	TCN	25*45*11
AP1338-F0	TCN	25 45 11				
AP1338-G01X7	TCV	25 45 11	F	113002N	TCN	25*45*11
AP1340-E1	TCN	25 45 12.5		410016N	TCN1	25*45*12.5
AE1344-E01X7	TC	25 46 7		107058N	TC	25*46*7
AF1347-E00X2	VB	25 47 5				
AC1348-E1B1	SC	25 47 8	A727	100079N	SC	25*47*8
AE1350-E11L4	TC	25 47 7	A727	100871N	TC	25*47*7
AEE261-A0	TC	25 47 8		106261N	TC	25*47*8
AEE594-A01	TC	25 47 10		110955N	TC	25*47*10
ACC387-A00X0	SC	25 50 10	A727	102861N	SC	25*50*10
AE1363-E01X2	TC	25 50 12		106617N	TC	25*50*12
BEE159-A00	TC	25 52 7		106174N	TC	25*52*7
UE0613-E0	TC	25 52 7	T303	106174N	TC	25*52*7
WC0048-A1	SC	25 52 8		104335N	SC	25*52*8
AE1374-E2	TC	25 52 8		104582N	TC	25*52*8
AEE204-A01X0	TC	25 52 10	A727	102489N	TC	25*52*10
	KB	25 52 11				
AEE968-A0	TC	25 52 12		108603N	TC	25*52*12
ABB968-A00	SB2	25 52 12		104750N	SB	25*52*12
BEE109-A0	TC	25 55 10		108047N	TC	25*55*10
AEE956-A00	TC	25 62 10		100146N	TC	25*62*10
AE1389-F02X2	TC	25 62 11	B			
BRR995-A0	Y	26 37.5 4.7	14			
BRR411-A0	TC4	26 37 10.5		104925N	TC4	26*37*10.5
BRR411-D0	DCY	26 37 10.5	TH			
AEE263-B0	TC	26 38 5	A727	113859N	TC	26*38*5
AEE292-A0	TC	26 38 7	A727	101603N	TC	26*38*7
BP3024-E1	SCJY	26 38 8.5				
BEE321-A00	TC	26 40 5		400945N	TC	26*40*5
ADD057-A01	TB	26 40 7				
AD1469-E01X8	TB	26 40 9		100215N	TB	26*40*9

NOK_NO	NOK			SOG		
	TYPE	SIZE		SOG_NO	TYPE3	PART_NO
AA9121-E02C1	SA2	69.85 90.12	12.7			
AA3483-F0	SA2	69.85 95.4	12.7			
AAA675-A00	TA2	69.85 98.45	11.9			
AEE182-A0	TC	70 85 8		102722N	TC	70*85*8
	SB	70 85 9		181556N	SB	70*85*9
BH1438-E0	HTC	70 87 8.5	C L			
AE3504-F0	TCC	70 88 9	B			
AEE036-A0	TC	70 88 12		114923N	TC	70*88*12
AHH036-A00	HTC	70 88 12	B L	114923N	TC	70*88*12
ADD036-B0	TB2	70 88 12		112007N	TB	70*88*12
ADD036-A07A0	TB	70 88 12	S500	112007N	TB	70*88*12
AE3505-E00B8	TC5	70 88 130	12			
AF3512-E02X4	VB2	70 90 10				
AEE479-A1	TC	70 90 10		100203N	TC	70*90*10
AH3512-F0	HTBP	70 90 10	B R			
BAA786-A0	TA2	70 90 10.3				
AE3513-E0	TC	70 90 12		103758N	TC	70*90*12
BHH556-A02X0	HTC	70 92 8.5	L S708			
BEE265-A00	TC	70 92 10	B	108104N	TC	70*92*10
AEE080-A0	TC	70 92 12		400186N	TC	70*92*12
AHH080-A00	HTC	70 92 12	R	400186N	TC	70*92*12
AH3519-R0	HTC9	70 92 12	18 BR			
AD3519-E1	TB3	70 92 12				
ARR080-A00	TB4	70 92 12				
AD7147-E0	TB9	70 92 13.5	20 B			
AD3521-G01X7	TB2	70 92 14				
BRR092-A01	TB4	70 92 14				
BH5163-E0	HTC9	70 94.5 10	16.7 BX			
AEE480-A00	TC	70 95 13		101218N	TC	70*95*13
AH3527-F0	HTC9	70 95 13	20 BR			
AP3527-B5	TCN	70 95 13		410302N	TCN1	70*95*13
AD3527-G1	TB2	70 95 13	B	100667N	TB	70*95*13
BW0487-E0	DB	70 95 16	C			
AH7327-E0	HTBW	70 95 14	20.5 BL			
BW0488-E00B1	DB	70 95 20				
AEE732-A0	TC	70 100 10		100952N	TC	70*100*10
AEE393-A00	TC	70 96 11				
BDD493-A00	TB2	70 100 12	B	100814N	TB	70*100*12
BEE009-A0	TC	70 100 13		103775N	TC	70*100*13
ACC729-A0	SC	70 110 8		114228N	SC	70*110*8
ADD149-A00	TB2Y	70 112 10	18			
BCC261-A00	SC	70 110 12		103267N	SC	70*110*12
BEE149-A00	TC	70 110 13		100170N	TC	70*110*13
ADD192-A0	TBY	70 112 14	20			
	TB6Y	70 111 23	13.5			
AA8076-F0	TA9Y	70 122 12	30.3 A			
AD3539-F00X8	TB2	70 115 13	B			
AE3540-F0	TC	70 115 15	B	106624N	TC	70*115*15
AA8077-E1	TA9Y	70 132 12	30.3 A			

NOK_NO	NOK			SOG		
	TYPE	SIZE		SOG_NO	TYPE3	PART_NO
BP2967-G0	SCJY	26.5 41 8.5		470224Y	SCJY	26.5*41*8.5
BHH591-A0	HTC	26 42 7 L T599		105111N	TC	26*42*7
AP1474-F10X3	TCV	26 42 8				
AE1475-E01B3	TC	26 43 8		107818N	TC	26*43*8
EZ8004-A1	PTS	26 43 16.3 B				
AEE941-A00	TC	26 45 6		110618N	TC	26*45*6
ACC055-A00X0	SC	26 45 7 A727		104348N	SC	26*45*7
AEE580-A00	TCY	26 52 7 8				
AEE552-A0	TC	26 52 8 A727		440020N	TC	26*52*8
AWW552-A01	DC	26 52 8		114676N	DC	26*52*8
WE0094-A0	TC	27 37 7		100592N	TC	27*37*7
BP5012-E	SCY	27 38 5.5				
BEE1000-A0	TC	27 38 5		108906N	TC	27*38*5
BEE322-A0	TC	27 38 6				
BRR860-A0	Y	27 39.5 4.5 12.2				
ARR168-C00	TC4	27 39 10.5		104898N	TC4	27*39*10.5
ACC219-A0	SC	27 40 6 A727		108475N	SC	27*40*6
AEE219-A0	TC6	27 40 6 A727				
AEE727-A00X0	TC	27 40 8 A727		103041N	TC	27*40*8
BP1519-E10X9	TCY	27.5 40 8				
AHH727-A00X0	HTC	27 40 8 R A727		103041N	TC	27*40*8
AH1508-E0	HTC	27 40 8 L FA10		103041N	TC	27*40*8
AE1510-E00L8	TC	27 42 7 A727		106915N	TC	27*42*7
BH3526-E0	HTC	27 43 6.7 B R				
AEE452-A0	TC	27 43 9 A727		110401N	TC	27*43*9
AHH452-A00	HTC	27 43 9 B R		110401N	TC	27*43*9
ADD452-A0	TB2	27 43 9		100643N	TB	27*43*9
AE1513-E00B9	TC	27 45 9		107210N	TC	27*45*9
AE1518-A00X5	TC	27 47 11				
	VC	27.5 48 6.5				
BFF378-A0	VB	28 35 4		112352N	VB	28*35*4
BFF472-A0	VB	28 37 4		114983N	VB	28*37*4
AEE469-A01X0	TC	28 38 7 A727		100093N	TC	28*38*7
ABB469-A0	SB	28 38 7		107138N	SB	28*38*7
BHH483-A0	HTCY	28 38 10 15 L A727				
AG1535-E01L2	VC	28 40 5 A727				
AEE635-A0	TC	28 40 7 A727		102944N	TC	28*40*7
AEE119-A00X0	TC	28 40 8 A727		400385N	TC	28*40*8
ADD119-A00	TB2	28 40 8		103736N	TB	28*40*8
AP7352-E06B1	TCL	28.6 40 8 8.6				
AWW119-A01	DC	28 40 8		104848N	DC	28*40*8
BP1848-E0	SCY	28 41 6.5				
BE2118-E00L2	TC	28 41 7 T599		111440N	TC	28*41*7
AEE142-A0	TC	28 42 7 A727		100451N	TC	28*42*7
AE1544-F01L5	TC	28 42 8 A727		104286N	TC	28*42*8
AH1544-E0	HTC	28 42 8 L		104286N	TC	28*42*8
ADD923-A0	TB2	28.6 43 6.5		103691N	TB	28.6*43*6.5
BE1772-F00	TC	28 44 6 T599		103837N	TC	28*44*6
BEE607-A0	TC	28 44 7		105072N	TC	28*44*7

NOK_NO	NOK			SOG		
	TYPE	SIZE		SOG_NO	TYPE3	PART_NO
AA8078-E03B7	TA9Y	70 142 12 36.3 B				
AD3541-E02X6	TB3	70 120 15				
AD7168-E02C9	TB9Y	70 135 14 18 B				
XW0126-E0	DBY	72.5 89.5 7.4 15.95				
BDD693-A00	TB2	72 94 10		105062N	TB	72*94*10
BEE662-A0	TC	72 94 12		107004N	TC	72*94*12
AH3560-G01X2	HTC	72 96 9 L S500				
BH6133-G0	HTC	73.5 89 8.5 F				
BDD667-A0	TB2	73 90 8		103357N	TZ	73*90*8
	TB2	73 95 14				
AAA907-A00	SA2	73.02 101.68 11.1				
BGG634-A00	VC	74 95 7		100232N	VC	74*95*7
BD1361-F0	TB2	74 100 10		114302N	TB	74*100*10
BH2120-E0	HTCK	74 97 12 B L				
BE5384-E0	TC3Y	74 156 14 22				
AEE738-A01	TCY	74 143 17.5				
AE3587-E03B9	TC3Y	74 142 14				
AEE180-A0	TC	75 92 12		108447N	TC	75*92*12
AB3607-G0	SB2	75 95 5		102613N	SB	75*95*5
BCC025-A0	SC	75 95 12		103262N	SC	75*95*12
AE3611-E0	TC	75 95 13		100603N	TC	75*95*13
ADD190-A00	TB2	75 95 13		100604N	TZ	75*95*13
AG3613-A0	VC	75 100 7				
AH3615-E0	HTC	75 100 8.5 C L		432782N	TC	75*100*8.5
BEE044-A0	TC	75 100 10		102736N	TC	75*100*10
BH0511-E00B4	HTB9	75 100 10 19.2BR				
AEE085-A0	TC	75 100 13		103824N	TC	75*100*13
AH3618-H0	HTC	75 100 13 B R		103824N	TC	75*100*13
AHH926-A0	HTC9	75 100 13 20 BR				
AP3618-G4	TCN	75 100 13		410303N	TCN1	75*100*13
ADD085-A03	TB2	75 100 13		101770N	TZ	75*100*13
AD3618-N00X2	TB2	75 100 13 B		101770N	TZ	75*100*13
AD3618-G1	TB	75 100 13 C		101770N	TZ	75*100*13
ARR085-A0	TB4	75 100 13				
AH3618-G0	HTBW	75 100 13 18 BR				
AH3618-L0	HTBW	75 100 13 20 BL				
GJ3618-J1	SA1J	75 100 13				
AA3618-E0	SA2	75 100 13		191678N	SA	75*100*13
AW3623-E03X8	DB2	75 100 20				
BAA931-A0	TAWY	75 108 10 19.5				
AA3628-E0	TA2	75 105 12		191928N	TA	75*105*12
AEE958-A00	TC	75 105 13		106622N	TC	75*105*13
AD3631-H0	TB	75 105 15		105069N	TB	75*105*15
AH8963-E0	HTBW	75 110 10 19.2 BR				
BH1352-E0	HTCS	75 110 12 18.5 BR				
AE3636-E01L0	TC	75 110 13 A727		103433N	TC	75*110*13
BZ5376-E0	CSK	75 114 15 C				
AAA077-A0	TAY	75 115 20.5				
AEE751-A0	TC	75 120 12		105186N	TC	75*120*12

SOG VS NOK

NOK_NO	NOK			SOG		
	TYPE	SIZE		SOG_NO	TYPE3	PART_NO
AE1545-F01X5	TC	28 44 8		109782N	TC	28*44*8
AE1550-K0	TC	28 45 8		104575N	TC	28*45*8
AEE999-A00	TC	28 45 10		105755N	TC	28*45*10
AEE120-A00X0	TC	28 47 8 A727		400668N	TC	28*47*8
AWW120-A00	DC	28 47 8		113171N	DC	28*47*8
AEE222-A0	TC	28 47 10		102540N	TC	28*47*10
AE1562-F1	TC	28 48 8		105448N	TC	28*48*8
	TB	28 48 8				
AEE008-A10X0	TC3	28 48 11 A103				
AP1563-A40X0	TCV	28 48 11				
AP1563-J1	TCN	28 48 11				
AD1563-G1	TB2	28 48 11		480315N	TZ	28*48*11
AFF231-B0	KB2	28 50 6				
BCC510-A0	SC	28 52 7 A727		102729N	SC	28*52*7
ACC748-S01X0	SC	28 52 10 A727		105915N	SC	28*52*10
BWW696-A00	DC	28 56 8		111791N	DC	28*56*8
AE1626-E01L3	TC	29 40 6 A103				
AD8849-P0	TB	29 41 7 B		113034N	TB	29*41*7
BHH817-A0	HTC	29 45 8 L S728		106918N	TC	29*45*8
BP1513-E1	TCV	29 47 9				
BE3060-E0	TC	29 52 11 B				
BFF225-A0	KB	30 37 4				
AB1651-F0	SB	30 39 7		104872N	TB	30*39*7
WE0109-A0	TC	30 40 7		101114N	TC	30*40*7
ABB163-A0	SB	30 40 7		100525N	SB	30*40*7
AEE957-A01X0	TC	30 40 8 A727		107865N	TC	30*40*8
ARR546-D01	TCL	30 40.5 10.5 12				
AHH244-A00	HTB	30 41 10 B L				
BCC854-A00X0	SC	30 42 6 A727		104734N	SC	30*42*6
AEE456-B01X0	TC	30 42 7 171A		100393N	TC	30*42*7
ADD456-A0	TB2	30 42 7		101749N	TB	30*42*7
AWW456-A00	DC	30 42 7		111931N	DC	30*42*7
AEE092-A00X0	TC	30 42 8 A727		101512N	TC	30*42*8
ADD092-A01	TB2	30 42 8				
AE1667-E0	TC	30 42 9		109454N	TC	30*42*9
ARR554-A0	TC4	30 42 10.5 A400				
ADD435-A00	TB2	30 43 8				
AEE684-A00X0	TC	30 44 7 A727		105357N	TC	30*44*7
AEE684-B0	TC	30 44 7 F585		105357N	TC	30*44*7
AD1673-F0	TB3	30 44 9				
AE1676-F01L1	TC	30 45 8 A727		106762N	TC	30*45*6
AEE026-B0	TC	30 45 8 A727		102534N	TC	30*45*8
AH1679-K0	HTC	30 45 8 B R		102534N	TC	30*45*8
ADD026-A0	TB2	30 45 8		101255N	TB	30*45*8
AHH026-A0	HSC	30 45 8 B R		101315N	SC	30*45*8
AE1681-E1	TC	30 45 11		107820N	TC	30*45*11
AZ6933-F05B2	Y	30 45 15 41 B				
AZ8045-E02D8	Y	30 45 15 44				
BHH687-B0	HTC	30 46 7 B R		101209N	TC	30*46*7

NOK_NO	NOK			SOG		
	TYPE	SIZE		SOG_NO	TYPE3	PART_NO
BDD1307-A0	TB2	75 121 13		100251N	TB	75*121*13
AD3639-G0	TBW	75 121 13 23				
BH5768-E0	HTC	76 94 8.5 F L				
AD3643-E11X3	TB	76 94 10				
BE4018-E01B2	TC	76 94 12 B		112241N	TC	76*94*12
BE1543-E0	TC3Y	76 157 8 14 B				
ADD049-A0	TB2	77 93 10		400819N	TB	77*93*10
BAA523-A00	TA3Y	77 102 10 19				
BH2081-E00C1	HTCK	78 100 12 B L				
AEE214-A0	TC	78 100 13		105158N	TC	78*100*13
BH1354-E0	HTBW	78 100 14 20 BL				
AA3695-E0	TAWY	78 115 10 19.5				
BE1037-E0	TC3Y	78 163 16				
AE3697-E0	TC3Y	78 162 16				
AAA534-A01	TAY	79.5 113 12 22				
BHH681-A01X0	HTC	80 100 8.5 L S708				
BEE013-A0	TC	80 100 10		100933N	TC	80*100*10
BHH013-A1	HTC	80 100 10 L T945		100933N	TC	80*100*10
BHH013-A01X0	HTC	80 100 10 L S728		100933N	TC	80*100*10
BHH013-B01X0	HTC	80 100 10 R S728		100933N	TC	80*100*10
AEE233-A01	TC	80 100 12		104554N	TC	80*100*12
AHH233-A02X0	HTC	80 100 12 L S500		104554N	TC	80*100*12
AEE254-A0	TC	80 100 13		100168N	TC	80*100*13
AHH254-B0	HTC	80 100 13 B L		100168N	TC	80*100*13
AR3735-E0	TB4	80 100 14				
AE3744-A01X7	TC	80 105 13 A727		400141N	TC	80*105*13
AHH276-A0	HTC	80 105 13 L S728		400141N	TC	80*105*13
AP3744-K5	TCN	80 105 13		410304N	TCN1	80*105*13
AB3744-H0	SB2	80 105 13		102117N	SB	80*105*13
ADD276-A00	TB2	80 105 13		100949N	TZ	80*105*13
AD3744-K1	TB	80 105 13 B		100949N	TZ	80*105*13
AD7169-E0	TB9	80 105 13 16.5 B				
BEE834-A00	TC	80 110 10		102614N	TC	80*110*10
BEE102-A00	TC	80 110 12		104226N	TC	80*110*12
AEE953-A00	TC	80 110 13		104280N	TC	80*110*13
BH1353-E0	HTAWY	80 124 10 26 BR				
BHH518-B1	HTC	80 96 9 L T945				
BHH518-B04X0	HTC	80 96 9 L S500				
XZ0124-E0	Y	80 96 10 18.3				
AH8776-E0	HTBW	80 127 16 24 BR				
BH5898-E0	HTB9Y	80 136 9 25 BX				
BH1456-E0	HTAWY	80 136 10 26 BR				
AE7943-E0	TC9Y	80 135 12 26 B				
AH7443-E0	HTBWY	80 143 10 37 B R				
AO9168-E01C9	OPY	80 141 10				
BH2755-E00X3	HTC5	82 105 10 C L				
AA3804-E04C1	SA2	82.55 108.05 11.91				
AHH068-A0	HTC5	82 105 13 L S728				
BA4113-E0	TAY	82 116 9.5 19.5				

NOK_NO	NOK			SOG		
	TYPE	SIZE		SOG_NO	TYPE3	PART_NO
BEE104-A00	TC	30 46 8		100221N	TC	30*46*8
BHH104-A00X0	HTC	30 46 8 R T303		100221N	TC	30*46*8
AE1690-E00X8	TC	30 46 10		102256N	TC	30*46*10
AEE646-B01X0	TC	30 47 7 A103		100432N	TC	30*47*7
AEE471-A00	TC	30 47 8		100758N	TC	30*47*8
BP2968-E0	SCJY	30 47 9		470227Y	SCJY	30*47*9
AEE453-A00	TC	30 47 10		100132N	TC	30*47*10
AEE964-A00	TC	30 48 7		102006N	TC	30*48*7
AD1699-E02X0	TB2	30 48 7		430656N	TM	30*48*7
AE1700-E0	TC	30 48 8		104774N	TC	30*48*8
AD1700-E00X1	TB	30 48 8 B				
AE1702-E0	TC	30 48 11				
WC0072-A0	SC	30 50 7		100687N	SC	30*50*7
AE1705-G0	TC	30 50 8 A727		103346N	TC	30*50*8
AD1705-E03X5	TB2	30 50 8				
AEE158-A0	TC	30 50 10		100186N	TC	30*50*10
AE1708-F0	TC5	30 50 10 B				
AE1709-A01M8	TC	30 50 11 A727		105336N	TC	30*50*11
AE1709-I01B3	TC6	30 50 11				
APP054-A0	TCV	30 50 11		115046N	TCN	30*50*11
AP1709-H4	TCN	30 50 11		410294N	TCN1	30*50*11
ADD054-A00	TB2	30 50 11		113900N	TB	30*50*11
BPS1473-A0	TCN	30 50 12.5		410017N	TCN1	30*50*12.5
AEE176-A0	TC	30 52 7 A727		102541N	TC	30*52*7
AE1720-E03N4	TC	30 52 8 A727		100135N	TC	30*52*8
ACC735-A00X0	SC	30 52 10 A727		100823N	SC	30*52*10
AQ1724-E03X1	QFK	30 52 10.5 12				
AEE472-A00	TC	30 52 11		106920N	TC	30*52*11
WE0050-A0	TC	30 55 7		102499N	TC	30*55*7
BCC206-A00	SC	30 55 10		101026N	SC	30*55*10
AE1734-E0	TC	30 55 10		100189N	TC	30*55*10
AEE980-A00X0	TC	30 55 12 A727		101257N	TC	30*55*12
AE17107-E0	TC	30 56 8 B		109414N	TC	30*56*8
AE8116-P00B8	TC	30 60 8		102749N	TC	30*60*8
WE0155-A0	TC	30 62 7		101119N	TC	30*62*7
AEE339-A00	TC	30 62 10		101197N	TC	30*62*10
AEE950-A00	TC	30 65 10		103898N	TC	30*65*10
AEE061-A0	TC	30 72 10		100958N	TC	30*72*10
AAA061-A01	SA2	30 72 10		194270N	SA	30*72*10
BEE106-A00	TC	30 75 9		110259N	TC	30*75*9
BRR419-A0	Y	31 43.3 5.6 13				
AE1793-E01X1	TC	31 43 8		110677N	TC	31*43*8
BRR275-A0	TC4	31 43 10 A400				
AE1794-E01	TC	31 45 9 A727				
BH4718-E0	HTC	31 46 7 C L				
BH2259-F0	HTC	31 46 8 C L				
AE1834-E0	TC	31.75 48 8				
AE1834-F0	TCL	31.75 48 8 9				
AA1849-F00X9	SA2	31.75 54.1 9.52				

NOK_NO	NOK			SOG		
	TYPE	SIZE		SOG_NO	TYPE3	PART_NO
BH2845-E0	HTC	83 100 9 C L				
ADD974-A0	TB2	84 100 10				
BHH798-A0	HTC	84 104 11 L F585				
BH5149-G0	HNAY	84 180 16.5 F				
BH4649-E0	HTC	85 103 8 FA20 L				
BH1445-E0	HTCK	85 102 13 C L				
BHH945-A0	HTC	85 105 10 B L		102769N	TC	85*105*10
AH3834-E0	HTC	85 105 10 C L		102769N	TC	85*105*10
BEE271-A00	TC	85 105 13 B		103178N	TC	85*105*13
BHH271-A0	HTC	85 105 13 B L		103178N	TC	85*105*13
AH3836-P04C0	HTC	85 105 13 C L		103178N	TC	85*105*13
AEE279-A0	TC	85 110 13		105044N	TC	85*110*13
AP3842-H2	TCN	85 110 13		410305N	TCN1	85*110*13
ADD279-A01	TB2	85 110 13		100979N	TZ	85*110*13
ADD279-B01X0	TB	85 110 13 T303		100979N	TZ	85*110*13
ADD279-B11A0	TB	85 110 13 S500		100979N	TZ	85*110*13
AR3842-F0	TB4	85 110 13				
AD3844-F00X1	TB	85 110 15				
AEE959-A0	TC	85 115 15		107980N	TC	85*115*15
AE3855-E0	TC	85 120 15		110257N	TC	85*120*15
AEE369-A0	TC	85 125 14		106931N	TC	85*125*14
UE0463-E00B7	TC	85 125 15 *				
AEE752-A0	TC	85 130 10		106703N	TC	85*130*10
BHH736-A00	HTC	86 100 10 B L		115149N	TC	86*100*10
BH1923-E0	HTBW	86 127 16 24 BR				
BH2088-E0	HTBWY	86 143 10 37 B R				
AA9113-E00B9	SA2	88.9 111.28 12.7 F				
AA3879-E0	TAP	88 115 13				
BH4746-E0	HTC9	89 109 9 10.3 F				
BH4127-E0	HTC	89 105 10 F L				
BZ5000-E0	Y	90 114 8 17 C				
BHH816-A1	HTC	90 110 9 L T945				
BHH816-A0	HTC	90 110 9 L S728				
BH0605-G0	HTC9K	90 110 9 10.3 CL				
BEE181-A0	TC	90 110 12		100786N	TC	90*110*12
BH6237-E0	HTC	90.5 114 12 F L				
AEE104-A0	TC	90 110 13		100518N	TC	90*110*13
AEE104-A1	TC	90 110 13 S500		100518N	TC	90*110*13
AE3932-A9	TC	90 115 13		103654N	TC	90*115*13
AP3932-B7	TCN	90 115 13		410306N	TCN1	90*115*13
AD3932-N0	TB2	90 115 13		105191N	TZ	90*115*13
AH7315-E0	HTB9	90 115 13 19 BR				
AE3933-E01X9	TCC	90 115 14 C				
AD3934-I10X5	TB	90 115 15				
AW3935-G0	DB2	90 115 20		431986N	DB	90*115*20
AEE481-A00	TC	90 120 12		102419N	TC	90*120*12
BEE832-A00	TC	90 120 13		103439N	TC	90*120*13
AZ3941-E03B1	Y	90 120 20				
AH3942-E0	HTBW	90 125 10 17 BR				

SOG VS NOK

NOK				SOG		
NOK_NO	TYPE	SIZE		SOG_NO	TYPE3	PART_NO
BF1171-F0	KB3Y	32 39 6 8				
AG8907-E0	VC	32 40 5 *		107366N	VC	32*40*5
AE1862-F0	TC	32 42 5		108074N	TC	32*42*5
BCC012-A00X0	SC	32 42 7 A727		105777N	SC	32*42*7
BHH571-A0	HTCY	32 42 10 12.5 L				
BEE572-A00X0	TC	32 43 7 A727		106666N	TC	32*43*7
AD1867-E40C9	TB	32 43 7				
BEE231-A01X0	TC	32 44 8 A727		106299N	TC	32*44*8
BWW231-C01B0	DC	32 44 8 A795		115220N	DC	32*44*8
ABB405-A0	SB	32 44 9		101086N	TB	32*44*9
ABB278-A00	SB	32 44 11				
AR1875-E00X0	TC4	32 44.5 12				
BCC210-A0	SC	32 45 7 A727		100662N	SC	32*45*7
AE1879-E0YY	TC	32 45 7 A727		100854N	TC	32*45*7
AD1879-E01X3	TB	32 45 7		103901N	TB	32*45*7
AEE093-A0	TC	32 45 8 A727		105071N	TC	32*45*8
AE1882-F0	TC	32 45 10 B		400779N	TC	32*45*10
AE1883-F1	TCY	32 45 11				
AH8338-E00X3	HTC	32 46 6 R T599				
AHH148-A00X0	HTC	32 46 6 R FB50				
BHH868-A0	HTC	32 46 7 L T945		101849N	TC	32*46*7
	SC	32 46 8		108369N	SC	32*46*8
AEE436-A00X0	TC	32 46 8 A727		108369N	TC	32*46*8
BHH514-A0	HTC	32 47 6 R T599		109511N	TC	32*47*6
BEE001-A0	TC	32 47 8		400300N	TC	32*47*8
BHH001-A0	HTC	32 47 8 B R		400300N	TC	32*47*8
AEE655-A00	TC	32 48 7		105470N	TC	32*48*7
AHH655-B0	HTC	32 48 7 R A727		105470N	TC	32*48*7
AEE009-A0	TC	32 48 8 A727		103138N	TC	32*48*8
AHH009-A00	HTC	32 48 8 R		103138N	TC	32*48*8
AH1894-G0	HTCK	32 48 8 B L				
AD1894-E04X9	TB2	32 48 8				
AEE110-A00X0	TC	32 48 10 A727		103631N	TC	32*48*10
AHH110-A00X0	HTC	32 48 10 L A727		103631N	TC	32*48*10
BHH465-A0	HTC	32 50 8 B R		101965N	TC	32*50*8
BE4192-E0	TCY	32 50 9 13.5 B				
UE0334-E00B2	TC	32 52 7 *		100757N	TC	32*52*7
AE1902-E02N1	TC	32 52 8 A727		104773N	TC	32*52*8
AW8321-E0	DC9	32 52 10.5 15.7 B				
AEE002-A01X0	TC	32 52 11 A727		103562N	TC	32*52*11
AE1904-G00X0	TC6	32 52 11				
AEE007-A00X0	TC9	32 52 11 15.5 T303		100019N	TC9	32*52*11/15.5
AP1904-F1	TCN	32 52 11		194895N	TCN1	32*52*11
AD1904-G0	TB	32 52 11		113902N	TB	32*52*11
AD1904-H1	TB	32 52 11 B		113902N	TB	32*52*11
BBB365-A00	SB2	32 52 12		104643N	SB	32*52*12
BH2844-E0	HTC	32 53 7 B R				
BEE031-A00X0	TC	32 54 10 A727		100136N	TC	32*54*10
AE1910-G02B6	TC5	32 54 10 B				

NOK			SOG		
NOK_NO	TYPE	SIZE	SOG_NO	TYPE3	PART_NO
AD3944-E12B7	TB2	90 125 15			
AD3945-F0	TB2	90 125 17 B			
AEE939-A01	TC	90 130 13	104200N	TC	90*130*13
AQ9151-E0	QLF	92 127.5 10.7 17.7			
ADD185-A00	TB2	92 135 14			
AA3970-E10B5	SA	93.66 120.68 15.9			
BQ2679-E01X0	QLF	93.5 130 11.5 20			
BF2991-F0	KB2Y	93 154 8 10.2			
AF7447-E07C6	KB2Y	93 157 8			
AB3973-G1	SB2	94 114 7	104873N	SB	94*114*7
BH5676-E0	HTC	94.5 114 12 F L			
AAA716-A01	TAY	94.5 132 12 22			
AHH303-A0	HTC	95 110 11 L S500	114034N	TC	95*110*11
UA0080-E00X7	TA2	95.25 114.3 11.9 *			
BH3276-E0	HTC	95 115 8.5 C L			
BHH1134-A0	HTC9	95 115 9.5 12 F585J			
AH3982-E0	HTC9K	95 115 9 11.5 CL			
BHH813-A0	HTC	95 118 10 L S728			
AH8846-G0	HTCK	95 118 10 FA20 L			
AEE940-A00	TC	95 115 12	400857N	TC	95*115*12
AHH940-A2	HTC	95 115 12 L T945	400857N	TC	95*115*12
AHH940-A01X0	HTC	95 115 12 L S708	400857N	TC	95*115*12
BEE570-A00	TC	95 115 13	100947N	TC	95*115*13
BEE011-A00	TC	95 120 13	103300N	TC	95*120*13
AH3994-P00X3	HTC	95 120 13 C L	103300N	TC	95*120*13
AP3994-B0	TCN	95 120 13	410307N	TCN1	95*120*13
AD3994-J1	TB	95 120 13 B	100228N	TZ	95*120*13
BRR011-A00	TB4	95 120 13			
AW9063-E07X8	DM	95 120 17 S500			
BH3099-E0	HTC5Y	95 127 15.7 25 CL			
AE4007-E0	TC	95 130 15 *	105460N	TC	95*130*15
AB4007-E0	SB2	95 130 15	106370N	TB	95*130*15
BGG095-A00	VC	95 135 13			
BHH558-A0	HTB5Y	96 113 15 L S708			
AH7026-F0	HTC9	96 124 14 21 B R			
AA9144-E02B5	SA2	98.42 120.8 12.7			
BF5117-E0	KB2Y	98.2 154.4 8 15.2			
AB4044-E05B7	SB	100 114 5			
BDD577-A0	TB2	100 114 7	104867N	TB	100*114*7
BE2073-E0	TC	100 114 10 B	114166N	TC	100*114*10
AD7700-E1	TB2	100 114 12	106989N	TZ	100*114*12
BCC637-A00	SC	100 120 10	100773N	SC	100*120*10
BEE581-A0	TC	100 120 12	104810N	TC	100*120*12
AHH927-A01	HTC	100 120 13 B R	106628N	TC	100*120*13
AH4056-P01B5	HTC	100 120 13 C L	106628N	TC	100*120*13
AH4056-H0	HTC9	100 120 13 18 C L	106990N	TC9	100*120*13/18
AHH936-A0	HTB5Y	100 120 15 L S500			
BH3258-E0	HTBIY	100 124 14.5 C L			
AHH937-A04X0	HTC5	100 125 12.5 L S708			

NOK_NO	NOK			SOG	
	TYPE	SIZE	SOG_NO	TYPE3	PART_NO
AE1912-F00X4	TC9	32 55 8 12.5 B			
AEE010-A00	TC3	32 55 9 B			
	VBY	32 57 12.8			
AHH021-A1	HTBP	32 58 12 R			
	VBY	32 59.5 10			
BD1355-F01B9	TB2Y	32 65 12 B			
ADD016-A0	TB	33 44 8	100050N	TM	33*44*8
BRR961-A0	Y	33 45.5 4.5 14			
BWW1106-A0	DC	33 45 8			
BRR840-A0	DCY	33 46 11	114356N	DC	33*46*11
BH1484-E0	HTC	33 47 8 B R	110104N	TC	33*47*8
ADD082-A00	TB	33.5 55 9.5			
BE2351-E0	TC9	33 59 11 17.5 B			
UP0450-E01Q0	TCN	33.02 72.29 9.5 *			
BHS1599-A0	HTC	34 46 7 F R	114365N	TC	34*46*7
BBB024-A00	SB2	34 46 8	101518N	SB	34*46*8
AR1964-H04X2	TB4	34 46 10.5			
AEE539-A00X0	TC	34 47 7.5 A727			
BP3158-E0	TCY	34 48 6.5 6.8 B			
BC3032-E01L5	SC	34 48 7.5 T599			
BEE550-A00X0	TC	34 48 8 A727	106591N	TC	34*48*8
BHH550-A0	HTC	34 48 8 B R	106591N	TC	34*48*8
AEE027-A00X0	TC	34 50 7 A727	400161N	TC	34*50*7
AP1973-F0	SBY	34 52 7 F	109264N	SB	34*52*7
AE1975-E0	TC	34 52 11	110319N	TC	34*52*11
BAA279-A00	SA2	34.92 53.98 11.1			
AW8760-E0	DC	34 54 8			
BCC872-A0	SC9Y	34 54 9 15.5			
AE1978-A00X7	TC	34 54 11	107963N	TC	34*54*11
AEE108-A00	TC	34 55 8			
BCC587-A00	SC9Y	34 63 9 15.5			
AFF165-A0	VB	35 42 4	112059N	VB	35*42*4
ADD143-A0	TB	35 44 7	106326N	TB	35*44*7
AF2033-E0	VB	35 45 5			
ACC107-A00	SCY	35 46 7			
AFF328-A00	VB	35 47 5	104754N	VB	35*47*5
AEE394-A0	TC	35 47 7	101585N	TC	35*47*7
ABB394-A00	SB	35 47 7	101070N	SB	35*47*7
	TC	35 48 6	112976N	TC	35*48*6
AEE963-A00	TC	35 48 7	100908N	TC	35*48*7
AEE128-A00X0	TC	35 48 8 A727	103213N	TC	35*48*8
AD2048-F0	TB	35 48 8	107853N	TB	35*48*8
ADD331-A00	TB5Y	35 48 13 15 B			
BH1882-E02L4	HTC	35 49 6 R T599			
ADD102-A01	TB	35.5 49.5 12.5			
	SB	35 50 5.5			
AE2056-E0	TC	35 50 7	103703N	TC	35*50*7
AEE979-A00X0	TC	35 50 8 A727	101513N	TC	35*50*8
AHH979-A0	HTC	35 50 8 R A727	101513N	TC	35*50*8

NOK_NO	NOK			SOG	
	TYPE	SIZE	SOG_NO	TYPE3	PART_NO
AEE069-A0	TC	100 125 13	100527N	TC	100*125*13
AP4063-B6	TCN	100 125 13	410308N	TCN1	100*125*13
ADD069-A0	TB2	100 125 13	401269N	TB	100*125*13
AR4063-E3	TB4	100 125 13			
BEE179-A00	TC	100 130 12	103810N	TC	100*130*12
AEE954-A0	TC	100 130 13	102361N	TC	100*130*13
	SC5	100 130 15.5			
	TC5Y	100 130 15.5			
BH2195-E0	HTC	100 135 10 C L	110640N	TC	100*135*10
AQ8958-E0	QLF	100.05 135 12 19.5			
AE4079-E0	TC	100 135 15	101939N	TC	100*135*15
BHH559-A01X0	HTC5	100 135 15 L S708			
AAA065-A05	TAY	100 145 26			
ACC658-A00	SC	100 150 12	105168N	SC	100*150*12
AA4086-E04B5	SAY	100 154 34			
ADD138-A0	TB3	101 114 10			
BH2201-F0	HTC	101 116 8 C L			
BH2201-E0	HTC	101 116 8 C R			
AH8165-F0	HTCK	101.57 125 13 C L			
ACC363-A00	SC	101.6 127 12.7	102448N	SC	101.6*127*12.7
BE1832-E00X5	TC	101.67 127 13			
ADD302-A0	TB	102 116 14	107982N	TB	102*116*14
BH1021-E0	HTB5Y	105 124 15 C L			
AEE488-A0	TC	105 125 13	102771N	TC	105*125*13
ACC982-A00	SC	105 130 13	440130N	SC	105*130*13
AE4150-F0	TC	105 130 13	113665N	TC	105*130*13
BH2153-E0	HTC	105 135 10 C L			
AH8279-E01X8	HTCK	105 135 13 C L			
AEE755-A00	TC	105 135 14	115336N	TC	105*135*14
AH4153-P02C5	HTC	105 135 14 C L	115336N	TC	105*135*14
AP4153-H0	TCN	105 135 14	410309N	TCN1	105*135*14
AH4153-Q0	HTCK	105 135 14 C L			
AD4153-I0	TB	105 135 14	480392N	TZ	105*135*14
AO4153-E00C5	OC	105 135 14			
AW4155-E0	DB2	105 135 18	410015N	DB	105*135*18
AHH739-A02X0	HTC	106 126 12 L S500			
BH1870-E0	HTC9	106 134 14 21 BR			
BD2580-E0	TBP	107 123 11			
BZ2374-E0	Y	107 180 17.5 C			
BZ2374-F0	Y	107 180 17.5 C *			
BEE050-A00	TC	110 130 12	101046N	TC	110*130*12
	Y 1	10 131.2 131.6 10.5 C			
AEE184-A00	TCY	110 140 13			
AEE973-A00	TC	110 140 14	104834N	TC	110*140*14
AH4212-P0	HTC	110 140 14 B L	104834N	TC	110*140*14
AP4212-B0	TCN	110 140 14	410310N	TCN1	110*140*14
AD4212-G2	TB	110 140 14	110945N	TB	110*140*14
AD4212-A21B2	TB	110 140 14 C	110945N	TB	110*140*14
AE4221-E01YY	TC	110 145 15 *	106480N	TC	110*145*15

SOG VS NOK

NOK_NO	NOK			SOG		
	TYPE	SIZE		SOG_NO	TYPE3	PART_NO
AEE379-A01	TC	35 65 12		101742N	TC	35*65*12
AD2132-F0	TB2	35 65 12 B		100194N	TZ	35*65*12
AEE006-A0	TC9	35 67 12 18 B		106780N	TC9	35*67*12/18
AH2134-H0	HTBSY	35 67 12 19 BR				
BEE166-A0	TC	35 72 10		101427N	TC	35*72*10
BAA220-A00	SA2	35 72 12		190959N	SA	35*72*12
BHH773-A0	HTC9Y	35 76 9 12.5 BR				
AH7363-E00X8	HTC5	35 80 9 L				
AE2146-E1	TC	35 80 11				
AAA987-A01	SA2	35 80 13		192823N	SA	35*80*13
BE3021-E0	TC	36 44 5		114124N	TC	36*44*5
BDD683-A00	TB	36 44 7				
BCC676-A01	SC	36 47 7		101225N	SC	36*47*7
BRR354-A00	DCY	36 48 11				
BHH468-A0	HTC	36 49 7 R T303				
BH4592-E0	HTC	36.5 50.5 7 FB50 R				
AE2164-E31B2	TC	36 50 10		115128N	TC	36*50*10
BH1434-E0	HTC	36 52 8 B		106921N	TC	36*52*8
BHH547-A00	HTC	36 52 10 B L		107509N	TC	36*52*10
AR2165-E01X2	TB4	36 52 11				
AG8912-E0	VC	36 55 6				
AE2170-E01X7	TC	36 58 12		107754N	TC	36*58*12
BCC021-A00	SC	36 62 7		105615N	SC	36*62*7
AR8894-E0	Y	37 50.3 5.6 14.7				
AH8740-F0	HTC	37 50 6 R T599				
AH8740-E01E1	HTB2	37 50 6 B R				
BG2257-E01X8	KC9	37 52 5.8 8.3				
BE5449-E0	TCY	37 55 9 11.5 B				
ABB123-A0	SB2	37 56 9		107923N	TB	37*56*9
AH7714-P0	HTC	37 57 10 B L		108079N	TC	37*57*10
AH7714-Q00C8	HTC	37 57 10 B R		108079N	TC	37*57*10
AC2205-E0	SCY	37 62 12.5				
AC2206-E03B0	SCY	37 62 14				
ACC935-A0	SC5Y	38 44 12.8 17.5				
AB7101-E0	SB	38 47 10		401265N	SB	38*47*10
FQ0301-Y01	PPY	38 48 6				
BH2851-E0	HTCY	38.2 49.2 8 12.1 BL				
AD8582-E0	TB	38 49.2 9 B		104669N	TZ	38*49.2*9
AH2216-E0	HTC	38 50 6 B R				
AD2216-F0	TB2Y	38 50 6 7				
BH4089-E0	HTCY	38 50 7.4 FA10L				
AE2218-E0	TC	38 50 8 A727		102606N	TC	38*50*8
BHH1101-B0	HTC	38 50 8 R T599		102606N	TC	38*50*8
AR6882-E00C1	TB4	38.1 50.8 10.5				
ACC285-A0	SC	38 51 6.4 A727				
BH2107-F0	HTB5Y	38 51 13 15 BL				
AFF445-B0	KB	38 52 6 A358		400073N	KB	38*52*6
AEE445-A0	TCS	38 52 6 14 A727				
AA2222-E0	TA2Y	38 52 7 7.3				

NOK_NO	NOK			SOG		
	TYPE	SIZE		SOG_NO	TYPE3	PART_NO
BD1304-E00X4	TB3	130 150 12				
ADD395-A0	TB2	130 150 14		101403N	TB	130*150*14
AE4446-E0	TCY	130 158.75 13				
AD4451-A03X2	TB	130 160 16				
AE4451-F0	TC	130 160 14		106002N	TC	130*160*14
AH7043-P7	HTC5Y	130 160 14.2 C L				
AD4451-A1	TB2	130 160 14 B		105185N	TZ	130*160*14
BOO096-A0	OC	130 160 14				
AH4457-E0	HTC3	130 161 14 C L				
BH3224-E02X7	HTC	133 157 14 C L				
AZ8854-P0	Y	135 157.4 12.5 C				
AD4494-E00X0	TB2	135 160 14				
AEE960-A01	TC	135 165 14		104979N	TC	135*165*14
AH4498-S00B5	HTC9	135 165 14 20.5 CL				
ADD972-A0	TB	138 152 12		103729N	TB	138*152*12
BH2658-F0	HTC	138 162 14 C L				
BQ4252-E0	QLNY	139.7 171.37 14.5 22F				
AE4535-F0	TCS	140 160 14 16.8				
ADD067-B0	TBP	140 160 14				
AEE961-A0	TC	140 170 14		111549N	TC	140*170*14
ADD961-A0	TB2	140 170 14		105186N	TZ	140*170*14
AD4555-E0	TB2	140 180 16		110678N	TB	140*180*16
AO4557-E0	OC	140 185 15				
BEE592-A01	TC	145 167 13		104159N	TC	145*167*13
AEE962-A0	TC	145 175 14		100777N	TC	145*175*14
AD4581-E0	TB3	145 175 14				
AO4581-G00D5	OC	145 175 14				
AE4588-E0	TC	145 190 16		110967N	TC	145*190*16
ADD933-A00	TBP	146 164 14				
AD4594-E1	TB3	146 170 14				
BDD685-A00	TBP	146 170 18				
BHH1032-A0	HTC	12.5 22 6 X T945				
AE4624-F6	TC	150 180 14		103268N	TC	150*180*14
AD4624-A0	TB2	150 180 14		183124N	TB	150*180*14
AR4624-G00C1	TB4	150 180 14				
AA9136-E0	SA2	152.4 178 15.88				
BDD1131-A0	TBP	154 175 13				
BDD932-A0	TBP	155 172 14				
BEE150-A0	TC	155 180 15		106800N	TC	155*180*15
ADD922-B00	TBP	155 180 17				
ADD985-A0	TB2	155 185 14 B		104900N	TB	155*185*14
AD4674-E0	TBP	155 190 17				
AD4678-F02B0	TB2	155 200 20				
AA4705-E0	SA2	160 182 10				
AD4713-A0	TB2	160 190 16		104320N	TB	160*190*16
ACC118-A01	SC	160 200 15		103912N	SC	160*200*15
AE4754-E0	TC	165 220 22.5				
WE0116-A0	TC	170 200 15		111039N	TC	170*200*15
AD4795-A04B1	TB2	170 200 16		104319N	TB	170*200*16

NOK_NO	NOK			SOG		
	TYPE	SIZE		SOG_NO	TYPE3	PART_NO
AEE379-A01	TC	35 65 12		101742N	TC	35*65*12
AD2132-F0	TB2	35 65 12 B		100194N	TZ	35*65*12
AEE006-A0	TC9	35 67 12 18 B		106780N	TC9	35*67*12/18
AH2134-H0	HTBSY	35 67 12 19 BR				
BEE166-A0	TC	35 72 10		101427N	TC	35*72*10
BAA220-A00	SA2	35 72 12		190959N	SA	35*72*12
BHH773-A0	HTC9Y	35 76 9 12.5 BR				
AH7363-E00X8	HTC5	35 80 9 L				
AE2146-E1	TC	35 80 11				
AAA987-A01	SA2	35 80 13		192823N	SA	35*80*13
BE3021-E0	TC	36 44 5		114124N	TC	36*44*5
BDD683-A00	TB	36 44 7				
BCC676-A01	SC	36 47 7		101225N	SC	36*47*7
BRR354-A00	DCY	36 48 11				
BHH468-A0	HTC	36 49 7 R T303				
BH4592-E0	HTC	36.5 50.5 7 FB50 R				
AE2164-E31B2	TC	36 50 10		115128N	TC	36*50*10
BH1434-E0	HTC	36 52 8 B		106921N	TC	36*52*8
BHH547-A00	HTC	36 52 10 B L		107509N	TC	36*52*10
AR2165-E01X2	TB4	36 52 11				
AG8912-E0	VC	36 55 6				
AE2170-E01X7	TC	36 58 12		107754N	TC	36*58*12
BCC021-A00	SC	36 62 7		105615N	SC	36*62*7
AR8894-E0	Y	37 50.3 5.6 14.7				
AH8740-F0	HTC	37 50 6 R T599				
AH8740-E01E1	HTB2	37 50 6 B R				
BG2257-E01X8	KC9	37 52 5.8 8.3				
BE5449-E0	TCY	37 55 9 11.5 B				
ABB123-A0	SB2	37 56 9		107923N	TB	37*56*9
AH7714-P0	HTC	37 57 10 B L		108079N	TC	37*57*10
AH7714-Q00C8	HTC	37 57 10 B R		108079N	TC	37*57*10
AC2205-E0	SCY	37 62 12.5				
AC2206-E03B0	SCY	37 62 14				
ACC935-A0	SC5Y	38 44 12.8 17.5				
AB7101-E0	SB	38 47 10		401265N	SB	38*47*10
FQ0301-Y01	PPY	38 48 6				
BH2851-E0	HTCY	38.2 49.2 8 12.1 BL				
AD8582-E0	TB	38 49.2 9 B		104669N	TZ	38*49.2*9
AH2216-E0	HTC	38 50 6 B R				
AD2216-F0	TB2Y	38 50 6 7				
BH4089-E0	HTCY	38 50 7.4 FA10L				
AE2218-E0	TC	38 50 8 A727		102606N	TC	38*50*8
BHH1101-B0	HTC	38 50 8 R T599		102606N	TC	38*50*8
AR6882-E00C1	TB4	38.1 50.8 10.5				
ACC285-A0	SC	38 51 6.4 A727				
BH2107-F0	HTB5Y	38 51 13 15 BL				
AFF445-B0	KB	38 52 6 A358		400073N	KB	38*52*6
AEE445-A0	TCS	38 52 6 14 A727				
AA2222-E0	TA2Y	38 52 7 7.3				

NOK_NO	NOK			SOG		
	TYPE	SIZE		SOG_NO	TYPE3	PART_NO
BD1304-E00X4	TB3	130 150 12				
ADD395-A0	TB2	130 150 14		101403N	TB	130*150*14
AE4446-E0	TCY	130 158.75 13				
AD4451-A03X2	TB	130 160 16				
AE4451-F0	TC	130 160 14		106002N	TC	130*160*14
AH7043-P7	HTC5Y	130 160 14.2 C L				
AD4451-A1	TB2	130 160 14 B		105185N	TZ	130*160*14
BOO096-A0	OC	130 160 14				
AH4457-E0	HTC3	130 161 14 C L				
BH3224-E02X7	HTC	133 157 14 C L				
AZ8854-P0	Y	135 157.4 12.5 C				
AD4494-E00X0	TB2	135 160 14				
AEE960-A01	TC	135 165 14		104979N	TC	135*165*14
AH4498-S00B5	HTC9	135 165 14 20.5 CL				
ADD972-A0	TB	138 152 12		103729N	TB	138*152*12
BH2658-F0	HTC	138 162 14 C L				
BQ4252-E0	QLNY	139.7 171.37 14.5 22F				
AE4535-F0	TCS	140 160 14 16.8				
ADD067-B0	TBP	140 160 14				
AEE961-A0	TC	140 170 14		111549N	TC	140*170*14
ADD961-A0	TB2	140 170 14		105186N	TZ	140*170*14
AD4555-E0	TB2	140 180 16		110678N	TB	140*180*16
AO4557-E0	OC	140 185 15				
BEE592-A01	TC	145 167 13		104159N	TC	145*167*13
AEE962-A0	TC	145 175 14		100777N	TC	145*175*14
AD4581-E0	TB3	145 175 14				
AO4581-G00D5	OC	145 175 14				
AE4588-E0	TC	145 190 16		110967N	TC	145*190*16
ADD933-A00	TBP	146 164 14				
AD4594-E1	TB3	146 170 14				
BDD685-A00	TBP	146 170 18				
BHH1032-A0	HTC	12.5 22 6 X T945				
AE4624-F6	TC	150 180 14		103268N	TC	150*180*14
AD4624-A0	TB2	150 180 14		183124N	TB	150*180*14
AR4624-G00C1	TB4	150 180 14				
AA9136-E0	SA2	152.4 178 15.88				
BDD1131-A0	TBP	154 175 13				
BDD932-A0	TBP	155 172 14				
BEE150-A0	TC	155 180 15		106800N	TC	155*180*15
ADD922-B00	TBP	155 180 17				
ADD985-A0	TB2	155 185 14 B		104900N	TB	155*185*14
AD4674-E0	TBP	155 190 17				
AD4678-F02B0	TB2	155 200 20				
AA4705-E0	SA2	160 182 10				
AD4713-A0	TB2	160 190 16		104320N	TB	160*190*16
ACC118-A01	SC	160 200 15		103912N	SC	160*200*15
AE4754-E0	TC	165 220 22.5				
WE0116-A0	TC	170 200 15		111039N	TC	170*200*15
AD4795-A04B1	TB2	170 200 16		104319N	TB	170*200*16

SOG VS NOK

NOK_NO	NOK			SOG		
	TYPE	SIZE		SOG_NO	TYPE3	PART_NO
AEE371-A00	TC	38 52 9		107231N	TC	38*52*9
AE2226-E00X0	TC	38 52 10		100436N	TC	38*52*10
ABB623-A00	SB2	38 52 10		101266N	SB	38*52*10
BHH774-A0	HTC9	38 54 8 11.5 BL				
BCC172-A00X0	SC	38 54 10 A727		104337N	SC	38*54*10
BH2634-F0	HTBY	38 55 7.7 B R				
AEE127-A00X0	TC	38 55 8 A727		106272N	TC	38*55*8
AHH127-A00B0	HTC	38 55 8 L A727		106272N	TC	38*55*8
AD2230-H0	TB	38 55 8 B				
AEE443-A0	TC	38 55 9		113664N	TC	38*55*9
AHH443-A00	HTC	38 55 9 B R		113664N	TC	38*55*9
ADD443-A00	TBP	38 55 9 B				
BCC053-A00X0	SC5	38 55 10 A727				
AE2238-E0	TC	38 58 7		108044N	TC	38*58*7
BHH553-A00X0	HTC	38.5 58 8.5 R T599				
AD2239-E0	TB	38 58 8		100038N	TB	38*58*8
AEE011-A0	TC	38 58 11 A727		104276N	TC	38*58*11
AEE003-A00X0	TC3	38.5 58 11 A727				
AP2240-A01F1	TCV	38 58 11				
AHH011-A0	HTC	38 58 11 L		104276N	TC	38*58*11
AH2304-H01X6	HTC	38.5 58 11 B R *				
AP2240-G01X6	TCN	38 58 11		410297N	TCN1	38*58*11
ADD011-A0	TBP	38 58 11				
BEE573-A0	TCY	38 60 8 14.5				
AE2245-E0	TC	38 60 11				
AA9139-E00X6	SA2	38.1 60.4 12.7				
BCC121-A00	SC	38 62 7		104302N	SC	38*62*7
	TBY	38 62 9 17.5				
AEE934-A00	TC	38 64 10		100599N	TC	38*64*10
ADD135-A0	TB2	38 65 9		106772N	TB	38*65*9
ADD106-A01	TB9	38 65 12 19				
ADD012-A12	TBP	38 74 11				
BHS1455-A0	HTBW	38 74 11 18.5 BX				
FQ0302-Y01	PPY	39.8 48 6				
BDS1545-A0	TB	39 50.5 8.4				
BR3715-F0	Y	39 51.5 4.7 11.5				
ACC437-A0	SCY	39 51 7.5 A727				
BR3714-E0	TCL	39 51.1 8 9.5				
BDD982-A0	TB9Y	39 52 6.3 11.3				
BEE168-A00X0	TC	39 52 7 A727				
BE5229-E	TC	39 53 9.5 B				
BE2350-E0	TC9	39 59 11 17 B		460206N	TC9	39*59*11/17
BBB670-A00	SBE	39 60 10				
AD6778-F0	TB5Y	39 60 13 B				
AHH051-A00	HTC	39.7 62 11 R				
AD2316-G0	TB2Y	39.6 62 11				
BCC549-A0	SC5Y	40 46 12.8 17.5				
AG8610-P0	VC	40 48 5				
AE2334-E00L3	TC	40 50 5 A727		108634N	TC	40*50*5

NOK_NO	NOK			SOG		
	TYPE	SIZE		SOG_NO	TYPE3	PART_NO
AE4801-E00X3	TC3	170 205 18				
AA4833-E02B5	SA2	174.62 200.23 15.88				
BD1675-E0	TB	180 200 16				
AD4943-E0	TB3	185 210 15				
ADD256-A0	TB2	190 220 16				
AD4983-A0	TB	190 225 16		105190N	TZ	190*225*16
AE4982-E0	TC	190 225 15		105290N	TC	190*225*15
ADD046-A0	TB2	190 225 18				
BW4526-E0	DB	190 225 21		113316N	DB	190*225*21
AC4993-E01X4	SC	190 245 22				
AD5068-A8	TB	200 240 20		112696N	TB	200*240*20
AD5080-F01B1	TB	200 255 25				
AE5205-E1	TC	220 250 16		104836N	TC	220*250*16
AD5208-E0	TB	220 255 18		108008N	TB	220*255*18
AB5264-E03X7	SB2Y	228.6 263.75 15.88				
AD5283-A0	TB	230 260 20		106354N	TB	230*260*20
AB5586-E0	SB	290 330 18		110704N	SB	290*330*18
AB0444-E01X2	SB	12.7 22.33 7.92 B				
AD0431-E06B6	TB	12.54 25.48 6.35		103554N	TB	12.7*25.4*6.35
AD7758-E01B0	TB	12.70 25.37 6.4 *		103554N	TB	12.7*25.4*6.35
ADD794-A0	TB	12.70 28.55 6.4		111116N	TB	12.7*28.58*6.35
BDD088-A00	TB	12.70 31.75 6.4		112296N	TB	12.7*31.75*6.35 W
AR8579-E0	TB	14.29 28.55 13.5				
AD0641-E0	TB	15.88 25.48 6.35		100306N	TB	15.88*25.4*6.35
BDD060-A00	TB	15.88 28.55 6.4		110102N	TB	15.88*28.58*6.35
AD7760-E0	TB	15.88 38.07 6.4 *				
UD0503-E00B3	TB	19.05 28.58 6.4		103916N	TB	19.05*28.58*6.35
ADD167-A00	TB2	19.05 31.75 6.4		105310N	TB	19.05*31.75*6.35
AD0915-F01X8	TB	19.05 31.75 7.9		430817N	TZ	19.05*31.75*7.95
AD0929-E01B1	TB	19.05 35.03 7.92		112531N	TB	19.05*34.92*7.95
AD7761-E01B2	TB2	19.05 38.07 6.4 *				
AD7762-E01B9	TB2	19.05 41.25 6.4 *		108307N	TB	19.05*41.28*6.35
AD8948-F0	TB2	19.05 47.6 6.4		109209N	TB	19.05*47.63*6.35
ADD570-A00	TB2	22.22 34.92 6.4		108739N	TB	22.23*34.92*6.35
AB9143-E0	SB2	22.17 35.03 7.9		460281N	SB	22.23*34.93*7.95
ADD829-A00	TB2	22.22 38.07 6.4		110615N	TB	22.23*38.1*6.35
ADD798-A00	TB2	22.22 41.25 6.4		101138N	TB	22.23*41.25*6.35
ADD830-A00	TB2	22.22 44.50 6.4				
ADD802-A00	TB2	25.40 41.25 6.4		105503N	TB	25.4*41.28*6.35
AD7765-E01X3	TB2	25.40 44.50 6.4 *		103024N	TB	25.4*44.5*6.35
AD6922-E02X6	TB2	25.40 47.60 6.4 *		460290N	TB	25.4*47.62*6.35
ADD787-A0	TB2	25.4 50.8 6.4		102993N	TB	25.4*50.8*6.35
BD1380-E0	TB	28.58 41.28 12.7				
AD1598-E03X7	TB	28.58 41.25 6.4 *		460302N	TB	28.58*41.28*6.35
ADD832-A0	TB2	28.58 47.60 6.4		107593N	TB	28.58*47.63*6.35
AD7096-E0	TB	28.58 47.6 7.9				
AD1617-F02B8	TB2	28.58 50.80 6.4 *		109662N	TB	28.58*50.8*6.35
BDD099-A0	TB2	30.16 44.50 6.4				
AD7769-E01X1	TB2	30.16 47.60 6.4 *				

NOK_NO	NOK			SOG		
	TYPE	SIZE		SOG_NO	TYPE3	PART_NO
AEE975-A0	TC	40 50 6.5		107001N	TC	40*50*6.5
AG2340-E0	VC	40 52 5		109479N	VC	40*52*5
ACC164-A02	SC	40 52 6		106105N	SC	40*52*6
BD1540-E0	TB9Y	40 52 6.5 10.3				
AEE017-B1	TC	40 52 7		106312N	TC	40*52*7
AH2342-E01M3	HTC	40 52 7 R T599		106312N	TC	40*52*7
ABB017-A00	SB2	40 52 7		100083N	SB	40*52*7
AAA017-A0	TA2	40 52 7		490018N	TA	40*52*7
BEE299-A00X0	TC	40 52 8 A727		104639N	TC	40*52*8
AEE169-A0	TC	40 52 8.5 A727				
AD2343-E01X6	TB	40 52 8		114193N	TB	40*52*8
BD2650-E0	TB5Y	40 53 12.5 25 B				
AFF053-A0	VB2	40 54 5		106450N	VB	40*54*5
BD2737-E02B0	TB	40 54 6				
BDD280-A00	TB	40 54 7		100889N	TZ	40*54*7
BG2664-E02X7	KC9	40 55 5.8 7.8				
BEE145-B0	TC	40 55 7		104572N	TC	40*55*7
WE0058-A0	TC	40 55 8 *		102157N	TC	40*55*8
AHH052-A00X0	HTC	40 55 8 R T303		102157N	TC	40*55*8
AD2359-G04X4	TB2	40 55 8		410038N	TB	40*55*8
AE2361-E01B8	TC	40 55 9		113694N	TC	40*55*9
ADD758-A0	TB2	40 55 9 B		401271N	TB	40*55*9
BH2465-E0	HTB	40 56 6.5 B R				
AH8847-P0	HTC	40 56 7 B R		100694N	TC	40*56*7
AEE641-A00X0	TC	40 56 8 T599		104023N	TC	40*56*8
AE2365-G0	TC9	40 56 8 13.6 B				
AE2365-F02B2	TC5Y	40 56 8 18 B				
BH3146-E0	HTC9	40 56 9 12.5 BX				
BEE268-A00	TC	40 56 10		400227N	TC	40*56*10
AE2366-F0	TCY	40 56 10 12				
AE2369-A0	TC	40 58 8 A727		104674N	TC	40*58*8
AHH981-A00X0	HTC	40 58 8 R A727		104674N	TC	40*58*8
AH2369-I0	HTC9	40 58 8 11.5 BR				
ADD774-A00	TB2	40 58 8		110786N	TB	40*58*8
GJ2370-F02X2	SCJY	40 58 8.5				
BH2080-G0	HTC9	40 58 9 14 FB50 L				
BHH768-A0	HTC	40 58 11 B L				
ACC454-B0	SC	40 60 10 T945		100282N	SC	40*60*10
WE0101-A0	TC	40 60 10		103050N	TC	40*60*10
AEE969-A00	TC	40 60 12		101271N	TC	40*60*12
AP2379-F0	TCN	40 60 12				
BEE176-A0	TC	40 62 7		100147N	TC	40*62*7
AGG177-A01	KC	40 62 8				
AES177-B3	TC	40 62 8		105163N	TC	40*62*8
AHH177-A0	HTC9	40 62 8 11.5 B R				
AEE528-A0	TC	40 62 9		105455N	TC	40*62*9
AAA528-A01	TA2	40 62 9				
AEE295-A0	TC	40 62 10		100191N	TC	40*62*10
AE2388-A04B6	TC	40 62 11 A727		105129N	TC	40*62*11

NOK_NO	NOK			SOG		
	TYPE	SIZE		SOG_NO	TYPE3	PART_NO
BDD425-A00	TB2	30.16 53.98 6.4		113514N	TB	30.18*53.97*6.35
AD1826-F01X0	TB2	31.75 44.50 6.4 *		106119N	TB	31.75*44.45*6.35
AD1832-E0	TB2	31.75 47.60 6.4 *		115033N	TB	31.75*47.63*6.35
ADD788-A00	TB2	31.75 50.80 6.4		109354N	TB	31.75*50.8*6.35
ADD624-A00	TB2	31.75 53.98 6.4				
ADD835-A00	TB2	33.34 53.98 7.9				
AD7774-E01B4	TB2	33.34 60.30 7.9 *		109111N	TB	33.35*60.33*7.95
ADD347-A10	TB2	34.92 50.80 7.9		100350N	TB	34.92*50.8*7.95
ADD821-A0	TB2	34.92 53.98 7.9		100304N	TM	34.92*53.97*7.95
ADD349-A0	TB2	34.92 57.15 12.7		108321N	TB	34.92*57.15*12.7
AD7775-E02X7	TB2	34.92 57.15 7.9 *		101552N	TB	34.92*57.15*7.93
AD7776-E01X1	TB2	34.92 60.30 7.9 *		103006N	TB	34.92*60.33*7.95
ADD541-A0	TB2	34.92 63.5 9.5		460303N	TB	34.92*63.5*9.53
ADD840-A00	TB2	36.51 63.55 7.9				
ADD841-A00	TB2	38.10 53.98 7.9		440131N	TB	38.1*53.98*7.93
ADD783-A0	TB2	38.10 57.15 7.9		440132N	TB	38.1*57.15*7.93
ADD843-A01	TB2	38.10 63.55 7.9		109193N	TB	38.1*63.5*7.95
ADD844-A00	TB2	39.69 60.30 7.9		111875N	TB	39.7*60.33*7.95
BDD359-A0	TB2	39.69 66.62 7.9				
AD2459-E01B5	TB2	41.28 60.30 7.9 *		101149N	TB	41.28*60.33*7.95
AD7789-E01X3	TB2	41.28 63.55 7.9 *		101150N	TB	41.28*63.55*7.95
ADD846-A00	TB2	41.28 66.62 7.9		106637N	TB	41.28*66.68*7.95
AD7791-E01B5	TB2	42.86 60.30 7.9 *				
ADD847-A01	TB2	42.86 63.55 7.9				
AD6916-E0	TB2	44.45 57.15 9.5				
AD7795-E01X6	TB2	44.45 60.30 7.9 *		107189N	TB	44.45*60.33*7.95
AD7095-E01X3	TB2	44.45 63.55 7.9 *		107109N	TB	44.45*63.5*7.95
AD2803-E01X9	TB2	44.45 76.07 12.7				
AD7799-E01B1	TB2	47.62 69.85 7.9 *		430568N	TB	47.63*69.85*7.95
AD7800-E02X4	TB2	47.62 73.02 7.9 *		109367N	TB	47.63*73.02*7.95
BB0301-E00X6	SB2	47.62 73.13 12.7				
AD7801-E01X8	TB2	47.62 76.20 7.9 *		106653N	TB	47.63*76.2*7.95
BDD255-A00	TB2	47.62 79.38 7.9				
BDD135-A00	TB2	49.21 66.62 7.9		114851N	TB	49.23*66.68*7.95
UD0154-E0	TB2	50.8 63.55 6.4		108713N	TB	50.8*63.5*6.35
ADD773-A00	TB2	50.80 66.62 7.9		104033N	TB	50.8*66.62*7.95
BDD062-A0	TB2	50.80 69.85 7.9		103981N	TB	50.8*69.85*7.95
ADD854-A00	TB2	50.80 73.02 7.9				
BB0331-E00X9	SB2	50.8 73.13 12.7				
AD2931-F02X1	TB2	50.80 76.20 7.9 *		108768N	TB	50.8*76.2*7.95
AD7808-E02B7	TB2	50.80 79.38 7.9 *				
AD2994-E01K7	TB2	53.98 73.02 9.5 *		100505N	TB	53.97*73.03*9.53
AD3000-E0	TB	53.98 76.2 12.7		102626N	TZ	53.97*76.2*12.7
AD7810-E01X2	TB2	53.98 76.20 9.5 *		108359N	TB	53.97*76.2*9.53
ADD857-A00	TB2	53.98 79.38 9.5		109552N	TB	53.97*79.38*9.53
BDD248-A00	TB2	53.98 81.00 11.9		109408N	TB	53.97*80.98*11.91
AD7658-E0	TB2	53.98 82.58 12.7		112205N	TB	53.97*82.55*12.7
AD7815-E01X7	TB2	55.56 79.38 9.5 *				
AD7153-E0	TB2	57.15 76.20 9.5 *		440117N	TB	57.15*76.2*9.5

SOG VS NOK

NOK_NO	NOK			SOG		
	TYPE	SIZE		SOG_NO	TYPE3	PART_NO
AP2388-A0	TCV	40 62 11		480317N	TCN	40*62*11
AP2388-E5	TCN	40 62 11		410298N	TCN1	40*62*11
AD2388-H00B8	TB	40 62 11		104892N	TB	40*62*11
BP3410-E0	TCVY	40 62 11 11.9 F				
AEE210-A0	TC	40 62 12		100550N	TC	40*62*12
AP2390-K1	TCN	40 62 12				
ADD210-A0	TB2	40 62 12		101508N	TB	40*62*12
AR2390-E0	TB4	40 62 12				
AP2390-P0	TCN	40 62 12 F624				
AE2396-F03L5	TC	40 63 7 A727		103648N	TC	40*63*7
BEE324-A0	TC	40 64 10		105677N	TC	40*64*10
BD2707-E0	TBSY	40 64 10 16 B				
AD2398-E02C5	TB5Y	40 64 12 B				
AD2398-F0	TBW	40 64 12 17.5 B				
AD8414-E01B4	TBWW	40 64 16				
AE2402-E0	TC	40 65 10		100096N	TC	40*65*10
BH6433-E0	HTC9	40 65 11.5 18.1				
BEE003-A01	TC	40 65 12		103051N	TC	40*65*12
BHH775-A00	HTC9	40 66 8 11.5 BR				
BCC146-A0	SC	40 68 10		103685N	SC	40*68*10
BDD589-A0	TB2	40 68 11		431379N	TB	40*68*11
BEE030-A0	TC	40 68 12		105244N	TC	40*68*12
BE3309-E0	TCY	40 70 8 10				
ACC715-A0	SC	40 72 7		101546N	SC	40*72*7
AE2419-E00L5	TC9	40 72 10 17.5 A727				
ABB098-A00	SB2	40 73 13				
BH5616-E0	HTBSY	40 74 9.5 18.8 BR				
BHH668-A00	Y	40 74.1 9 19.5				
ADD099-A00	TB2	40 74 10				
ADD087-A0	TB9	40.5 74 10 19				
BD3063-E00X2	TBSY	40 75 10 16.5 B				
AEE725-A00	TC	40 75 12		102546N	TC	40*75*12
AH7288-E0	HTC9	40 75 12 17.5 BR				
AH7288-K0	HTBSY	40 75 12 21.3 BR				
BHH776-B0	HTC9Y	40 76 9 12.5 BL				
BHH776-A0	HTC9Y	40 76 9 12.5 BR				
AEE601-A0	TC	40 80 10		106898N	TC	40*80*10
ACC588-A00	SC	40 90 12		105378N	SC	40*90*12
ABB588-A00	SB2	40 90 12		103924N	SB	40*90*12
BC1769-E01B4	SC5Y	41 47 12.8 16.7				
BR4268-F0	Y	41 53.5 4.8 11.7				
AAA018-A0	TA2	41 53 7		193560N	TA	41*53*7
BR3976-F0	TCL	41 53.1 8 9.5				
BR2004-F0	Y	41 54.3 5.6 14.7				
BR2003-F0	DCY	41 54 11		108770N	DC	41*54*11
BD2106-E0	TB2	41 55 6		100501N	TB	41*55*6
ADD031-A01	TB2	41 56 7		101644N	TZ	41*56*7
ADD280-A01	TB2	41 58 9				
BH3670-F0	HTC9	41 59 10 15 BR				

NOK_NO	NOK			SOG		
	TYPE	SIZE		SOG_NO	TYPE3	PART_NO
BDD067-A00	TB2	57.15 79.38 9.5				
AD7817-E01K6	TB2	57.15 82.58 9.5 *		108807N	TB	57.15*82.55*9.53
ADD807-A00	TB2	57.15 85.62 9.5		100529N	TB	57.15*85.72*9.53
AD3253-E0	TB2	60.32 79.38 9.5 *		102860N	TZ	60.32*79.37*9.52 R
ADD763-A00	TB2	60.32 82.58 9.5		105792N	TB	60.33*82.55*9.53
AD3256-F0	TB	60.32 85.06 17.8				
ADD860-A00	TB2	60.32 85.62 9.5				
AD3338-F01K1	TB2	63.50 82.58 9.5 *		431604N	TB	63.5*82.55*9.53
ADD862-A00	TB2	63.50 85.62 9.5		114906N	TB	63.5*85.73*9.53 W
AD3347-E01K2	TB2	63.50 88.90 9.5 *		107336N	TB	63.5*88.9*9.52
AD7079-F01K0	TB2	63.50 92.02 9.5 *				
ADD864-A00	TB2	66.68 92.02 9.5				
AD7825-E01K6	TB2	66.68 95.28 9.5 *		108246N	TB	66.68*95.25*9.53
AD3478-E01K4	TB2	69.85 88.90 9.5 *		109834N	TB	69.85*88.9*9.53
AD7828-E01X5	TB2	69.85 92.02 9.5 *				
ADD777-A00	TB2	69.85 98.45 9.5		410050N	TB	69.85*98.45*9.52
ADD867-A00	TB2	73.02 92.02 9.5		101948N	TB	73.02*92.07*9.53
AD3591-E0	TB	74.63 101.68 16.7 B				
ADD868-A0	TB2	76.20 95.28 11.1		114779N	TB	76.2*95.25*11.13
ADD775-A01	TB2	76.20 101.68 11.1 *		105483N	TB	76.2*101.68*11.13
AD7833-E01X5	TB2	76.20 104.78 11.1				
AD3673-E01X9	TB2	76.20 107.92 15.9		101947N	TB	76.2*107.95*15.88
AD3675-E01X3	TB	76.20 111.12 15.9		112721N	TB	76.2*111.13*15.88
AD3705-E01X5	TB2	79.38 104.78 12.7 *		114337N	TB	79.38*104.78*12.7
AD7834-E01X2	TB2	79.38 111.15 12.7 *		112678N	TB	79.38*111.13*12.7
AD3796-E01K6	TB2	82.55 107.92 12.7 *		108890N	TB	82.55*107.95*12.7
AD7836-E0	TB2	82.55 111.15 12.7 *				
AD3808-E04E8	TB2	82.55 114.30 11.1		108303N	TB	82.55*114.3*11.13
AD3809-E01X2	TB2	82.55 114.30 12.7 *		106249N	TB	82.55*114.3*12.7
ADD872-A00	TB2	82.55 117.50 12.7		109026N	TB	82.55*117.48*12.7
ADD875-A00	TB2	85.72 117.50 12.7		109151N	TB	85.73*117.48*12.7
AD3891-E01K0	TB2	88.90 114.30 12.7 *		107436N	TB	88.89*114.3*12.7
ADD878-A01	TB2	88.90 120.65 12.7 *				
ADD815-A0	TB2	95.25 126.97 12.7		114853N	TB	95.25*127*12.7
AD4096-E11B5	TB	100.02 136.52 17.5				
AD4092-E04B9	TB6	100.01 136.53 12.7				
AD4109-E01X2	TB2	101.60 126.97 12.7 *		104550N	TB	101.6*127*12.7
ADD883-A00	TB2	101.60 133.35 12.7		107538N	TB	101.6*133.35*12.7
ADD885-A0	TB2	107.95 133.35 12.7		180654V	TB	107.95*133.35*12.7
ADD889-A0	TB2	107.95 139.7 12.7				
ADD816-A00	TB2	114.30 139.70 12.7		101952N	TB	114.3*139.7*12.7
BDD066-A0	TB2	120.65 146.05 12.7		104174V	TB	120.65*146.05*12.7
AD4371-E12X1	TB2	120.65 165.1 15.9				
AD7859-E01X9	TB2	127 152.43 12.7 *		106656N	TB	127*152.48*12.7
AD4488-F01X3	TB2	133.35 165.1 15.9		104882N	TB	133.35*165.1*15.88
AD4645-P0	TB	152.40 171.45 11.9 C				
AD4651-E2	TB	152.4 187.32 19				
UC0393-E0	SC	9.52 20.75 6.4 A727				
UP0402-E00G6	TCV	11.11 22.22 6.4 A795				

NOK			SOG		
NOK_NO	TYPE	SIZE	SOG_NO	TYPE3	PART_NO
BH3670-G0	HTC9	41 59 10 17.8 BR			
BH5276-F0	HTC9Y	41 61 9 13.5 X			
AE2452-E01X6	TC	41.27 65 12			
BH6832-F0	HTC9	41 74 11 18.5 T945X			
BH4701-F0	HTC	42.5 54.5 6 FB50 R			
AD2480-E0	TB2	42 55 6	105301N	TB	42*55*6
AEE032-A0	TC	42 55 7	101688N	TC	42*55*7
ADD032-B0	TBY	42 55 7	102593N	TM	42*55*7
AEE045-A00X0	TC	42 55 9 A727	102358N	TC	42*55*9
AH2483-E01B4	HTC	42 55 9 B R	102358N	TC	42*55*9
ADD045-A0	TB2	42 55 9	100649N	TB	42*55*9
BG1583-E01X7	KC	42 56.2 6	104591N	KC	42*56.2*6
BF2595-E02X1	KB	42 58 7	105372N	KB	42*58*7
WE0098-A0	TC	42 58 8 *	110719N	TC	42*58*8
ADD430-A01	TB2	42 58 10			
BH3937-F0	HSC	42 59 7.7 B R			
AEE074-A00X0	TC	42 60 7 A727	104175N	TC	42*60*7
AHH074-A0	HTC	42 60 7 R T599	104175N	TC	42*60*7
AP2492-F0	SBY	42 60 7 F	113352N	SB	42*60*7
	SC	42 60 9	105032N	SC	42*60*9
AEE212-A0	TC	42 60 9	105032N	TC	42*60*9
AD2493-E0	TB	42 60 9	111619N	TB	42*60*9
AD2493-I0	TB2	42 60 9 B	111619N	TB	42*60*9
BEE267-A00	TC	42 62 7	100148N	TC	42*62*7
AE8798-E0	TCY	42 62 8 9			
AEE473-A0	TC	42 62 10	100192N	TC	42*62*10
BH4226-E0	HTC	42 62 10 B L	100192N	TC	42*62*10
	OVB	42 65 6			
AE2504-F0	TC	42 65 9	105064N	TC	42*65*9
AW2506-F0	DC	42 65 11 B			
AEE195-A00	TC	42 65 12	105063N	TC	42*65*12
AP2507-H0	TCN	42 65 12	410299N	TCN1	42*65*12
AHH195-A0	HTB	42 65 12 R	113237N	TB	42*65*12
BEE033-A0	TC	42 72 10	103076N	TC	42*72*10
ADD271-A0	TB2	42 72.5 12			
AE2520-F0	TC9	42 76 12 21 B	100013N	TC9	42*76*12/21
AH2520-G0	HTBSY	42 76 12 21.3 BR			
BD2357-E0	TBY	43 54 6.5			
BBB307-A0	SBY	43 54 7.5			
AGG020-A00	KCY	43 55 8			
BR3655-E0	TCL	43 55.1 9.5 10.5			
AH7886-F0	HTC	43 60 9 B R			
AC2541-E00X0	SC	43 61 9			
BH2050-E00X5	HTB2	43 63 9 B R			
AH8303-P00X8	HTC9	43 63 12 19 B R			
BEE1317-A0	TC3	44 56 8			
BHH120-A00X0	HTC	44 60 7 R T303	103534N	TC	44*60*7
BHH120-C0	HTC	44 60 7 R F585J	103534N	TC	44*60*7
AD2554-F00C8	TB	44 60 7 B	110311N	TB	44*60*7

NOK			SOG		
NOK_NO	TYPE	SIZE	SOG_NO	TYPE3	PART_NO
AEE891-A0	TC	11.11 25.4 6.4 A103			
UE0300-E00B1	TC	12.7 25.4 6.4 A103	401060N	TC	12.7*25.4*6.35
AE0452-E06B2	TC	12.7 25.4 7.9	101412N	TC	12.7*25.4*7.93
BRR191-A0	TC4	12.4 25.4 7.9 A400			
BCC519-A0	SC	12.7 28.57 7.9 A727	108061N	SC	12.7*28.58*7.95
UR0374-E1	TC4	14.25 25.35 6.4 A727			
AEE330-A0	TCY	15.88 23.83 4.8 A727			
ACC365-A00X0	SC	15.88 25.4 4.8 A727	107668N	SC	15.88*25.4*4.76
BEE100-A0	TC	15.88 25.4 6.4	112036N	TC	15.88*25.4*6.35
UE0052-F0	TCY	15.88 27.76 7.9 9.5TH			
AEE378-A0	TC	15.88 28.58 6.4 A103	103422N	TC	15.88*28.58*6.35
AEE461-A01	TCY	15.88 28.58 7.9 10.3			
AE0654-E2	TC	15.88 31.75 6.4 A103	108595N	TC	15.88*31.75*6.35
UC0151-E0	SC	15.88 34.92 6.4 T303	102172N	SC	15.87*34.92*6.35
AEE896-A0	TC	17.46 28.58 6.4 A103	108036N	TC	17.48*28.58*6.35
APP820-A0	TCV	17.45 31.75 6.4 A795			
BC1349-E0	SC	18.54 41.28 7.9 A727			
AE0900-E0	TC	19.05 28.58 6.4 *	106613N	TC	19.05*28.58*6.35
UE0742-E0	TC	19.05 31.75 6.4 A727	104084N	TC	19.05*31.75*6.35
ACC600-A0	SC	19.05 34.92 6.4 A727			
ACC154-A0	SC	19.05 34.92 7.9 A727	110112N	SC	19.05*34.92*7.95
AE0934-F0	TC	19.05 38.1 6.4 A727	104945N	TC	19.05*38.1*6.35
AE7698-E0	TC	19.05 40 7.9 *			
AC7395-E0	SC	20.64 31.78 9.5 T303			
UP0285-E0	TCV	20.62 34.92 7.9 A795			
UE0149-F0	TC	22.3 31.75 4.8 T303	460246N	TC	22.23*31.75*4.78
AP1182-E0	TCV	22.22 34.92 7.9 A795			
AEE438-A0	TC	22.22 35.15 9.5 A727	103350N	TC	22.23*35.15*9.53
UP0007-E00Q5	TCV	22.22 38.02 6.4 A795			
AE8364-E1	TC	22.25 38.07 7.9 A727	107061N	TCN	22.23*38.1*7.95
AP1190-E0	TCV	22.22 38.1 7.9 A795	107061N	TCN	22.23*38.1*7.95
AP8240-E1	TCV	24.81 42.82 7.9 A795			
AP8214-F0	TCV	24.81 44.5 7.9 A795			
UP0119-E0	TCV	25.4 38.07 6.4 A795	432351N	TCN	25.4*38.1*6.35
AEE258-A00	TC	25.4 38.1 7.9	113343N	TC	25.4*38.1*7.95
UP0284-E0	TCV	25.4 38.07 7.9 A795			
AP7926-G0	TCV	25.4 41.2 6.4 A795			
ACC247-A0	SC	25.4 44.45 9.5 A727			
ACC787-A0	SC	25.4 50.8 6.4 A727	108194N	SC	25.4*50.8*6.35
AE6890-F0	TC	26.99 46.99 7.5 T599			
UE0110-E00B4	TC	28.58 39.7 6.4 A727			
AEE778-A01X0	TC	28.58 44.5 6.4 A727	107516N	TC	28.58*44.45*6.35
AEE309-A0	TC	28.58 47.62 9.5 A727	104946N	TC	28.58*47.63*9.53
UE0273-E0	TC	31.75 41.28 4.8 A727	115293N	TC	31.75*41.28*4.78
AE8548-E0	TC	31.75 42.85 6.4 A727	101423N	TC	31.75*42.86*6.35
AE8898-E00X3	TC	31.75 44.68 9.9 A727			
AP8540-E0	TCV	31.75 44.5 9.9 A795			
AEE917-A0	TC	31.75 50.8 7.9 A727	107565N	TC	31.75*50.8*7.95
ACC346-A00X0	SC	31.75 50.8 9.5 A727			

SOG VS NOK

NOK_NO	NOK			SOG		
	TYPE	SIZE		SOG_NO	TYPE3	PART_NO
BEE004-A0	TC	44	60 9	102833N	TC	44*60*9
BEE005-A00	TC	44	62 8	103036N	TC	44*62*8
AEE499-A00	TC	44	62 9	109979N	TC	44*62*9
BBB923-A0	SBW	44	63 7 9.5			
BDD922-A0	TBWY	44	63 13 13.5			
ADD047-A01	TB2	44.45	65 10			
AHH179-A0	HTC3	44	65 11 B R			
AH7689-I0	HTC	44	68 8 B L	112499N	TC	44*68*8
ACC498-A00	SC	44	68 12.8	100230N	SC	44*68*12.8
AA8652-P00X4	SA2	44.45	68.33 12.7			
	VB2Y	44.45	69.04 10.30			
	DC5Y	44	72 6.7 8.7			
	HTC5Y	44	72 7.6 8 L			
ADD413-A0	TB	45	55 7.5	400488N	TB	45*55*7.5
ADD297-A01	TB2	45	58 9	105145N	TB	45*58*9
ACC424-A00	SC	45	60 7	100858N	SC	45*60*7
AEE424-A0	TC	45	60 7	110498N	TC	45*60*7
BCC300-A00	SC	45	60 8	100587N	SC	45*60*8
AE2643-E13L0	TC	45	60 9 A727	102826N	TC	45*60*9
AD2643-F2	TB	45	60 9	106906N	TB	45*60*9

NOK_NO	NOK			SOG		
	TYPE	SIZE		SOG_NO	TYPE3	PART_NO
AEE441-A0	TC	32.54	49.21 12.7A727	115178N	TC	32.54*49.23*12.7
AP7862-F00B2	TCV	33.34	49.17 7.9 A795			
BE1177-E00B8	TC	34.92	44.53 6.4 B *	114731N	TC	34.92*44.45*6.35
AC8202-E2	SC	34.92	47.6 7.9 T303	103486N	SC	34.92*47.63*7.95
AEE347-A0	TC	34.92	50.8 7.9 A727	106574N	TC	34.93*50.8*7.95
BEE392-A0	TC	34.92	52.37 7.9 T599	106575N	TC	34.93*52.4*7.95
UE0294-E0	TC	34.92	57.15 7.9 T599	103418N	TC	34.92*57.15*7.95
AEE525-A0	TC	36.51	59.13 9.5 A727			
AE7368-E0	TC	38.1	50.8 7.9 A727	110143N	TC	38.1*50.8*7.95
UE0482-F0	TC	38.1	52.37 6.4 T303			
AEE324-A0	TC	38.1	57.15 6.4 A727			
AEE317-A00	TC	38.15	60.38 12.7	432173N	TC	38.1*60.32*12.7 W
AEE321-A00	TC	39.85	66.68 12.7			
ACC264-A01X0	SC	44.45	54 4.8 A727	430065N	SC	44.45*53.97*4.75
ACC790-A0	SC	44.45	57.15 7.9 A104	100855N	SC	44.45*57.15*7.95
	SC	44.45	61.91 9.52			
AEE679-A00	TC	50.8	76.2 9.5	108205N	TC	50.8*76.2*9.53
AEE249-A00	TC	57.15	76.2 9.5	104124N	TC	57.15*76.2*9.53
ACC360-A0	SC	76.2	95.25 9.5	430062N	SC	76.2*95.25*9.52
AEE682-A00	TC	88.9	114.3 9.5	112608N	TC	88.9*114.3*9.53
AE7431-E0	TC	114.3	152.4 12.7 *	106071N	TC	114.3*152.4*12.7