

LAMONS®

LAMONS GASKET COMPANY

Web: www.lamonsgasket.com



THE GASKET COMPANY
ISO - 9002 CERTIFIED

DOUBLE COLOR CODING

Lamons SpiraSeal® Gaskets are color coded on the entire outside edge of the centering ring, permitting identification of the winding materials at a glance, whether the gasket is in storehouse stock or installed between flanges. The metal is designated by a solid color. Filler materials, are identified by a number of stripes placed at equal intervals around the outside edge of the centering ring. These colors conform to the Industry Standard for metal and filler materials.

METALLIC WINDING MATERIALS

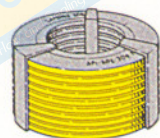

304 SS
Yellow

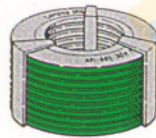

316L SS
Green

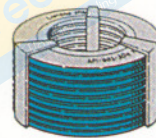

321 SS
Turquoise

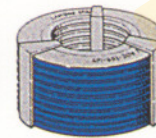

347 SS
Blue

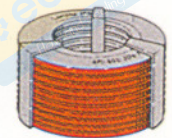

Monel®
Orange

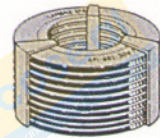

Alloy 20
Black

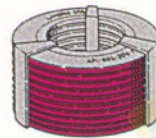

Titanium
Purple

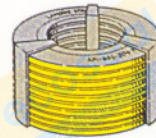

Inconel® 600
Gold

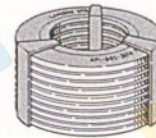

Incoloy®
White

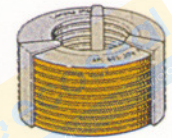

Hastelloy® B
Brown

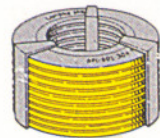

Hastelloy® C
Beige

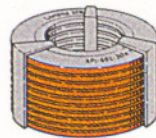

Phosphor Bronze
Copper

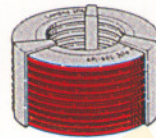

Nickel
Red

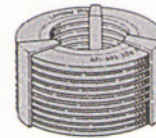

Carbon Steel
Silver

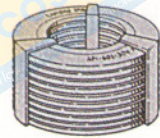

304L SS

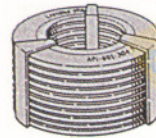

317L SS

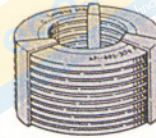

310 SS

NON-METALLIC FILLERS (304 SS Windings)

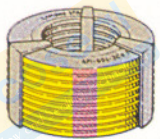

Chlorocarb®
Light Pink Stripe

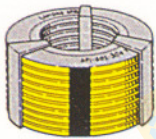

Grafoil®
Gray Stripe

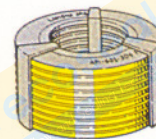

Teflon®
White Stripe

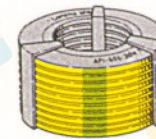

Ceramic
Light Green Stripe

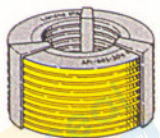

Glass Filled
Teflon®

*No color code
®Registered Trademark

INTRODUCTION

Since 1947 Lamons Metal Gasket Company has been furnishing gaskets for heat exchangers, pressure vessels and piping connections in refineries, petrochemical and other plants. Gaskets are supplied both for original installations and replacements. Lamons provides gaskets meeting customers' requirements of size, pressure, temperature, shape and materials. Lamons' growth has been due to high quality and fast service.

CROSS-SECTIONAL VIEWS

SpiraSeal Gasket Styles and Shapes

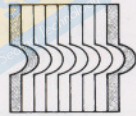

W

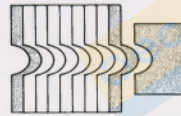

WR

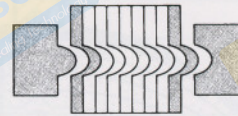

WRI

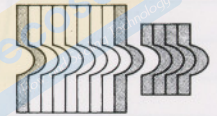

WG



WP



L

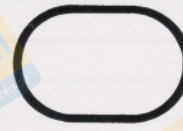

H



MW

Dimensions and other information given by this catalog subject to change without notice.

SPECIFICATIONS FOR GASKETS AND FLANGES

ASME B16.20

This specification, developed by the American Society of Mechanical Engineers, covers ring joint, jacketed and spiral wound gaskets for standard flanges. Spiral wound gasket sizes are listed for use with ASME/ANSI B16.5 flanges from 1/2" through 24" nps for 150/lb through 1500/lb and from 1/2" through 12" nps for 2500/lb (see table, page 4).

ASME B16.5

A broad specification covering steel pipe flanges and flanged fittings in a variety of sizes and pressures. Many styles of gaskets are available to fit these flanges.

ASME B16.47 Series A or MSS SP-44

Specifications covering large diameter flanges. Spiral wound gasket dimensions for these flanges are listed by pressure class and nominal pipe size on page 6.

ASME B16.47 Series B or API 605

Specifications covering large diameter flanges. Spiral wound gasket dimensions for these flanges are listed by Pressure class and nominal pipe size beginning at the bottom of page 7.

MIL-G-24716

A government specification covering spiral wound gaskets for the Navy and Defense Department for 150/lb through 2500/lb pipe line flanges. Special requirements may apply, consult with Lamons.

MIL-G-15342

A specification covering spiral wound gaskets for handhole and manway covers in boilers used by the Navy. It does not include nuclear boilers.

LAMONS SPIRASEAL GASKETS

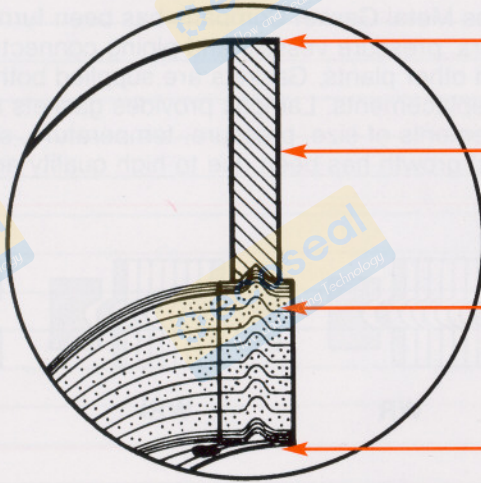

Color coding the entire outer edge of gauge ring identifies the metal in the winding whether the gasket is in the line or in inventory.

Zinc plating protects gauge rings against corrosion.

A wide choice of metals and non metallic filler materials is available to permit selection of the most suitable combination for specific conditions.

Lamons electronically controlled and "programmed" machines insure consistent quality in all "SpiraSeal®" gaskets through uniform and correct spacing of spot welds around the entire I.D.

STOCK COMPONENTS

WINDING METALS

L.C. Steel
304
304L
316L
317L
321
347
410
Monel® 400
Nickel
Inconel® 600, 625 & 750
Incoloy® 800 & 825
Alloy 20
Titanium
Hastelloy® B, C, X & G
Copper
Zirconium
Tantalum
Phosphor Bronze

INNER OR OUTER RING METALS

Steel
304
304L
316
316L
321
347
410
501
Monel®
Nickel
Inconel®
Titanium
Hastelloy® B
Hastelloy® C

NON-METALLIC FILLERS

Chlorocarb® (Non-Asbestos)
PTFE
Glass Filled PTFE
Ceramic
Grafoil®

SUPERIOR CONSTRUCTION

"SpiraSeal" gaskets are made of alternate plies of preformed metal and a soft non-metallic filler. The metal winding of the gasket is formed into a "chevron" configuration allowing superior resiliency and self-adjustment when compared to conventional gaskets. The density of the SpiraSeal gasket can be varied to meet virtually any requirement. Electronic controls on Lamons' "SpiraSeal" machines assure high quality precision welding with equal spacing, the correct number of metal plies on the gasket inside periphery, proper ratio of metal to filler, proper number of metal plies on the outside and at least three spot welds on the O.D. The soft non-metallic filler is essentially flush with the metal winding on both contact faces of the gasket, thus producing a smooth sealing surface.

CUSTOM ENGINEERED

Lamons "SpiraSeal" spiral wound gaskets are manufactured on specially designed and built machinery. These machines incorporate the latest advances in electronic circuitry and automation to insure consistent high quality production. With this advanced machinery Lamons can meet rigid specifications and produce exactly identical gaskets regardless of size or quantity.

SIZES AND APPLICATIONS

Lamons SpiraSeal gaskets are available in wide ranges of sizes and thicknesses.**Proper gasket design must consider the operating conditions and joint assembly to be sealed. The wide variety of different styles of Lamons SpiraSeal gaskets allows the engineer to choose the right one for each particular application. SpiraSeal gaskets can be furnished for vacuum to extremely high pressures, for temperatures from cryogenic to 2000° F.

MATERIALS

"SpiraSeal" gaskets are available for order in almost any combination of component materials. Adjacent is a listing of normally stocked materials for SpiraSeal windings and components. Lamons is constantly adding new materials to stock and welcomes inquiries on any material.

DOUBLE COLOR CODING

Lamons standard size SpiraSeal WR gaskets are double color coded for easy identification of the winding metal and filler while the gasket is on the shelf or installed between flanges. The metal is designated by a solid color on the entire outside edge of the centering ring. Filler materials are identified by a number of stripes placed at intervals around the outside edges of the centering ring.

**See applicable style selections for size limitations

LAMONS SPIRASEAL STYLE WR GASKETS

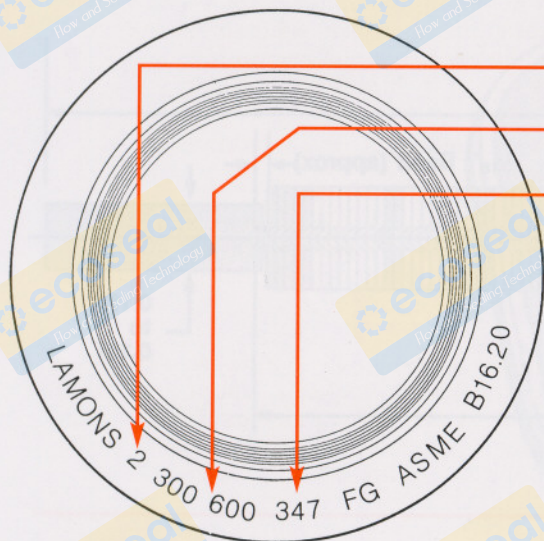

Nominal pipe size

Pressure rating

Winding metal

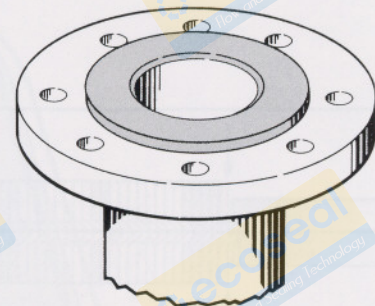

ASME B16.20 or applicable specification

Filler material

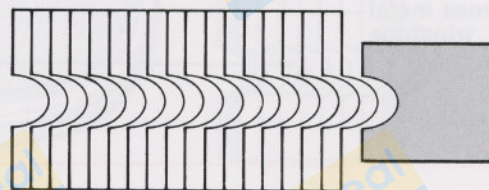

MARKING

Centering rings of "SpiraSeal" Style WR Gaskets are stamped with information as shown in the illustration above. Other information such as special inner or outer ring material may also be stamped on the outer ring.

Style WR Gaskets have a spiral wound sealing section with a solid metal outer ring. These self-centering gaskets with a built-in compression gauge are used to seal:

- Raised face and raised face slip-on joints
- Plain or flat face joints
- Van Stone joints
- Lapped joints
- Welding neck flanged joints

"SpiraSeal" Style WR Gaskets are available in standard sizes for ASME B16.5 Flanges in petrochemical and refinery piping in accordance with ASME B16.20, in all sizes and pressure ratings covered by these standards. This type gasket is also available in standard sizes to MIL-G-24716 and DIN specifications.

Standard Style WR Gaskets are manufactured of Type 304 Stainless Steel winding and Chlorocarb® (non-asbestos) non-metallic filler. Lamons standard non-asbestos material Chlorocarb® (Mica-Graphite) performs similarly to asbestos in many applications. Additional technical data and specifications are available on request. Standard WR Gaskets are fabricated and stocked for all sizes and series. WR Gaskets are available on special order with a choice of any metal winding and non-metallic filler listed on page 2.

Sealing members of Standard "SpiraSeal" WR Gaskets are manufactured to a thickness of .175", ± 0.005 " measured across the metal windings. Optimum compression ranges from a thickness of .125" to .135", dependent upon flange finishes and operating conditions. Within this range, compression of the gasket provides adequate seating loads and further adjustments can be made. Simple feeler gauge measurements may be used to determine compression where precision is required.

Unless otherwise specified, the standard gauge ring thickness is 0.117" to 0.131". The carbon steel gauge ring is an integral part of this spiral wound gasket. It performs the following important functions:

- Centers the gasket in the joint
- Furnishes extra radial strength to help prevent gasket blow-out
- Resists atmospheric conditions
- Helps prevent overcompression of the sealing element

LAMONS STYLE WR GASKETS (Con't.)

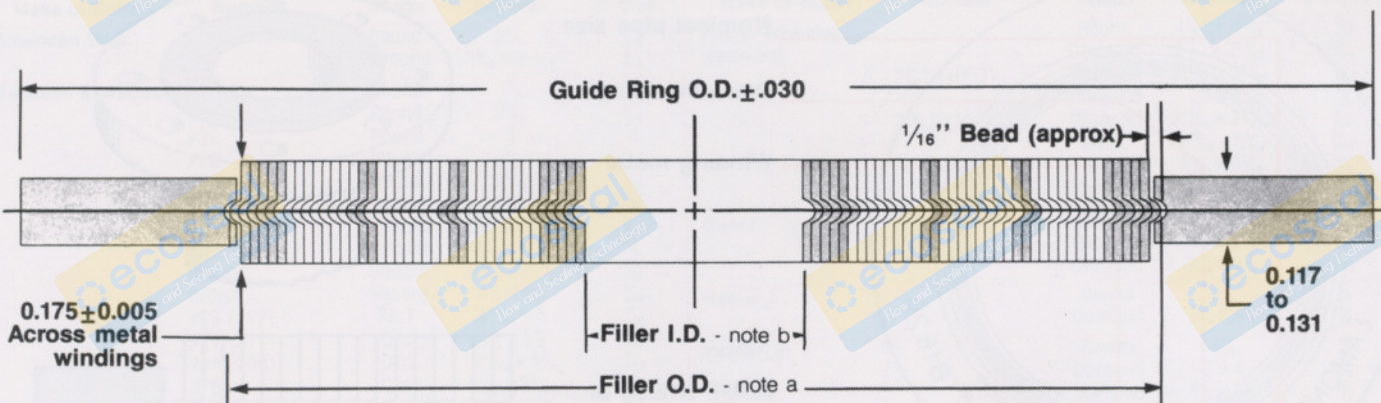

SPIRASEAL STYLE WR GASKETS note c (Dimensions Per ASME B16.20 for ASME B16.5 Flanges)

*Not listed in ASME B16.20

Nom. Pipe Size	FILLER OD CLASSES		150lb.		300 lb.		400 lb.		600 lb.		900 lb.		1500 lb.		2500 lb.	
	150, 300 400, 600	900, 1500 2500	I.D.	O.D.	I.D.	O.D.	I.D.	O.D.	I.D.	O.D.	I.D.	O.D.	I.D.	O.D.	I.D.	O.D.
1/4"	7/8	—	1/2	1 3/4	1/2	1 3/4	1/2	1 3/4	1/2	1 3/4	—	—	—	—	—	—
1/2	1 1/4	1 1/4	3/4	1 7/8	3/4	2 1/8	3/4	2 1/8	3/4	2 1/8	3/4	2 1/2	3/4	2 1/2	3/4	2 3/4
3/4	1 9/16	1 9/16	1	2 1/4	1	2 5/8	1	2 5/8	1	2 5/8	1	2 3/4	1	2 3/4	1	3
1	1 7/8	1 7/8	1 1/4	2 5/8	1 1/4	2 7/8	1 1/4	2 7/8	1 1/4	2 7/8	1 1/4	3 1/8	1 1/4	3 1/8	1 1/4	3 3/8
1 1/4	2 3/8	2 3/8	1 7/8	3	1 7/8	3 1/4	1 7/8	3 1/4	1 7/8	3 1/4	1 9/16	3 1/2	1 9/16	3 1/2	1 9/16	4 1/8
1 1/2	2 3/4	2 3/4	2 1/8	3 3/8	2 1/8	3 3/4	2 1/8	3 3/4	2 1/8	3 3/4	1 7/8	3 7/8	1 7/8	3 7/8	1 7/8	4 5/8
2	3 3/8	3 3/8	2 3/4	4 1/8	2 3/4	4 3/8	2 3/4	4 3/8	2 3/4	4 3/8	2 5/16	5 5/8	2 5/16	5 5/8	2 5/16	5 3/4
2 1/2	3 7/8	3 7/8	3 1/4	4 7/8	3 1/4	5 1/8	3 1/4	5 1/8	3 1/4	5 1/8	2 3/4	6 1/2	2 3/4	6 1/2	2 3/4	6 5/8
3	4 3/4	4 3/4	4	5 3/8	4	5 7/8	4	5 7/8	4	5 7/8	3 3/4	6 5/8	3 5/8	6 7/8	3 5/8	7 3/4
3 1/2"	5 1/4	5 1/4	4 1/2	6 3/8	4 1/2	6 1/2	4 1/8	6 3/8	4 1/8	6 3/8	4 1/8	7 1/2	4 1/8	7 3/8	—	—
4	5 7/8	5 7/8	5	6 7/8	5	7 7/8	4 3/4	7	4 3/4	7 5/8	4 3/4	8 1/8	4 5/8	8 1/4	4 5/8	9 1/4
5	7	7	6 1/8	7 3/4	6 1/8	8 1/2	5 13/16	8 3/8	5 13/16	9 1/2	5 13/16	9 3/4	5 5/8	10	5 5/8	11
6	8 1/4	8 1/4	7 3/16	8 3/4	7 3/16	9 7/8	6 7/8	9 3/4	6 7/8	10 1/2	6 7/8	11 3/8	6 3/4	11 1/8	6 3/4	12 1/2
8	10 3/8	10 3/8	9 3/16	11	9 3/16	12 1/8	8 7/8	12	8 7/8	12 5/8	8 3/4	14 1/8	8 1/2	13 7/8	8 1/2	15 1/4
10	12 1/2	12 1/4	11 5/16	13 3/8	11 5/16	14 1/4	10 13/16	14 1/8	10 13/16	15 3/4	10 7/8	17 1/8	10 1/2	17 1/8	10 5/8	18 3/4
12	14 3/4	14 1/2	13 3/8	16 1/8	13 3/8	16 5/8	12 7/8	16 1/2	12 7/8	18	12 3/4	19 5/8	12 3/4	20 1/2	12 1/2	21 5/8
14	16	15 3/4	14 5/8	17 3/4	14 5/8	19 1/8	14 1/4	19	14 1/4	19 3/8	14	20 1/2	14 1/4	22 3/4	—	—
16	18 1/4	18	16 5/8	20 1/4	16 5/8	21 1/4	16 1/4	21 1/8	16 1/4	22 1/4	16 1/4	22 5/8	16	25 1/4	—	—
18	20 3/4	20 1/2	18 11/16	21 5/8	18 11/16	23 1/2	18 1/2	23 3/8	18 1/2	24 1/8	18 1/4	25 1/8	18 1/4	27 3/4	—	—
20	22 3/4	22 1/2	20 11/16	23 7/8	20 11/16	25 3/4	20 1/2	25 1/2	20 1/2	26 7/8	20 1/2	27 1/2	20 1/4	29 3/4	—	—
24	27	26 3/4	24 3/4	28 1/4	24 3/4	30 1/2	24 3/4	30 1/4	24 3/4	31 1/8	24 3/4	33	24 1/4	35 1/2	—	—

NOTE:

ASME B16.20 calls for the use of inner rings on these sizes of gaskets to prevent over compression damage which might occur due to the high available bolt loading. See page 13 for dimensions of inner rings. The purchaser should specify the material desired for inner ring construction.

- a The gasket outside-diameter tolerance for NPS 1/2 through NPS 8 is ± 0.03 , for NPS 10 through NPS 24, $+0.06$ inch, -0.03 inch.
- b The gasket inside-diameter tolerance for NPS 1/2 through NPS 8 is ± 0.016 , for NPS 10 through NPS 24, ± 0.03 inch.
- c ASME B16.20 calls for the use of inner rings with PTFE filled Spiral wound gaskets in all sizes and Pressure classes.

MAXIMUM BORE OF ASME/ANSI B16.5 FLANGES FOR USE WITH SPIRAL-WOUND GASKETS (WITHOUT INNER RINGS)

This table shows the maximum bore of flanges for which the spiral-wound gasket dimensions shown on page 4 are recommended considering the tolerances involved, possible eccentric installation, and the possibility that the gasket may extend into the assembled flange bore.

Flange Size (NPS)	Pressure Class							
	75	150	300	400	600	900 ¹	1500 ¹	2500 ¹
1/2								
3/4		WN flange only ²			WN flange only ²			
1								
1 1/4		SO flange ³ WN flange ²		No flanges Use Class 600	SO flange ³ WN flange ²	No flanges Use Class 1500		WN flange only ²
1 1/2								
2		SO flange ³ WN flange, any bore			SO flange ³ WN flange, any bore			
2 1/2								
3					SO flange ³ WN flange, any bore			
4	No flanges							WN flange with SW bore (includes nozzle ⁴ but excludes SO flange)
6					WN flange with schedule 10S bore described in ASME B36.19M (includes nozzle (4) but excludes SO flanges)			
8								
10							WN flange with Schedule 80 bore (excludes nozzle (4) and SO flange (5))	
12		SO flange WN flange, any bore						
14								
16					WN flange with schedule 10 bore described in ASME B36.19M (includes nozzle (4) but excludes SO flange) (5)			
18								
20								No flanges
24								

GENERAL NOTES

- (A) This table shows the maximum bore of flanges for which the spiral-wound gasket dimensions shown on Page 4 are recommended considering the tolerances involved, possible eccentric installation, and the possibility that the gasket may extend into the assembled flange bore.
- (B) For maximum permissible flange bores for inner rings, see ASME B16.20.
- (C) Abbreviations: SO = slip on and threaded WN = welding neck SW = standard wall

NOTES:

- (1) Inner rings are required for Class 900 gaskets, NPS 24; Class 1500 gaskets, NPS 12 through NPS 24; and Class 2500 gaskets, NPS 4 through NPS 12 (see ASME B16.20). These inner rings may extend into the pipe bore a maximum of 0.06 in. under the worst combination of maximum bore, eccentric installation, and additive tolerances.
- (2) In these sizes the gasket is suitable for a welding neck flange with standard wall bore, if the gasket and the flanges are assembled concentrically. This also applies to a nozzle. It is the user's responsibility to determine if the gasket is satisfactory for a flange of any larger bore.
- (3) Gaskets in these sizes are suitable for slip-on flanges only if the gaskets and flanges are assembled concentrically.
- (4) A nozzle is a long welding neck; the bore equals the flange NPS.
- (5) An NPS 24 gasket is suitable for nozzles.

RECOMMENDED SIZES FOR LARGE DIAMETER FLANGES

ASME B16.47 SERIES A or MSS-SP-44 GASKET SIZES

ASME B16.47 SERIES A or MSS-SP-44 SPIRAL WOUND GASKET 150 LB

Gaskets manufactured to this standard are for raised-face, weld neck flanges as described in the flange specification (not included in this catalog).

Pipe Size	Gasket Size	Pipe Size	Gasket Size
22	22 ³ / ₄ × 24 × 26	42	42 ¹ / ₂ × 44 ¹ / ₄ × 48
26	26 ¹ / ₂ × 27 ³ / ₄ × 30 ¹ / ₂	44	44 ¹ / ₂ × 46 ³ / ₈ × 50 ¹ / ₄
28	28 ¹ / ₂ × 29 ³ / ₄ × 32 ³ / ₄	46	46 ¹ / ₂ × 48 ³ / ₈ × 52 ¹ / ₄
30	30 ¹ / ₂ × 31 ³ / ₄ × 34 ³ / ₄	48	48 ¹ / ₂ × 50 ³ / ₈ × 54 ¹ / ₂
32	32 ¹ / ₂ × 33 ⁷ / ₈ × 37	50	50 ¹ / ₂ × 52 ¹ / ₂ × 56 ¹ / ₂
34	34 ¹ / ₂ × 35 ⁷ / ₈ × 39	52	52 ¹ / ₂ × 54 ¹ / ₂ × 58 ³ / ₄
36	36 ¹ / ₂ × 38 ³ / ₈ × 41 ¹ / ₄	54	54 ¹ / ₂ × 56 ¹ / ₂ × 61
38	38 ¹ / ₂ × 40 ³ / ₈ × 43 ³ / ₄	56	56 ¹ / ₂ × 58 ¹ / ₂ × 63 ¹ / ₄
40	40 ¹ / ₂ × 42 ³ / ₈ × 45 ³ / ₄	58	58 ¹ / ₂ × 60 ¹ / ₂ × 65 ¹ / ₂
		60	60 ¹ / ₂ × 62 ¹ / ₂ × 67 ¹ / ₂

ASME B16.47 SERIES A or MSS-SP-44 300 LB SPIRAL WOUND GASKET

Pipe Size	Gasket Size	Pipe Size	Gasket Size
22	22 ³ / ₄ × 24 ³ / ₄ × 27 ³ / ₄	44	44 ¹ / ₂ × 46 ¹ / ₂ × 48
26	27 × 29 × 32 ⁷ / ₈	46	46 ³ / ₈ × 48 ³ / ₈ × 50 ³ / ₈
28	29 × 31 × 35 ³ / ₈	48	48 ³ / ₈ × 50 ³ / ₈ × 52 ³ / ₈
30	31 ¹ / ₄ × 33 ¹ / ₄ × 37 ¹ / ₂	50	51 × 53 × 54 ¹ / ₄
32	33 ¹ / ₂ × 35 ¹ / ₂ × 39 ³ / ₈	52	53 × 55 × 56 ¹ / ₄
34	35 ¹ / ₂ × 37 ¹ / ₂ × 41 ³ / ₈	54	55 ¹ / ₄ × 57 ¹ / ₄ × 58 ³ / ₄
36	37 ⁵ / ₈ × 39 ⁵ / ₈ × 44	56	57 ¹ / ₄ × 59 ¹ / ₄ × 60 ³ / ₄
38	38 ¹ / ₂ × 40 × 41 ¹ / ₂	58	59 ¹ / ₂ × 61 ¹ / ₂ × 62 ³ / ₄
40	40 ¹ / ₄ × 42 ³ / ₈ × 43 ³ / ₈	60	61 ¹ / ₂ × 63 ¹ / ₂ × 64 ³ / ₄
42	42 ¹ / ₄ × 44 ³ / ₈ × 45 ³ / ₈		

ASME B16.47 SERIES A or MSS-SP-44 400 LB SPIRAL WOUND GASKET

Pipe Size	Gasket Size	Pipe Size	Gasket Size
22	22 ³ / ₄ × 24 ³ / ₄ × 27 ⁵ / ₈	44	44 ¹ / ₂ × 46 ¹ / ₂ × 48 ¹ / ₂
26	27 × 29 × 32 ³ / ₄	46	47 × 49 × 50 ³ / ₄
28	29 × 31 × 35 ¹ / ₈	48	49 × 51 × 53
30	31 ¹ / ₄ × 33 ¹ / ₄ × 37 ¹ / ₄	50	51 × 53 × 55 ¹ / ₄
32	33 ¹ / ₂ × 35 ¹ / ₂ × 39 ¹ / ₂	52	53 × 55 × 57 ¹ / ₄
34	35 ¹ / ₂ × 37 ¹ / ₂ × 41 ¹ / ₂	54	55 ¹ / ₄ × 57 ¹ / ₄ × 59 ³ / ₄
36	37 ⁵ / ₈ × 39 ⁵ / ₈ × 44	56	57 ¹ / ₄ × 59 ¹ / ₄ × 61 ³ / ₄
38	38 ¹ / ₄ × 40 ¹ / ₄ × 42 ¹ / ₄	58	59 ¹ / ₄ × 61 ¹ / ₄ × 63 ³ / ₄
40	40 ³ / ₈ × 42 ³ / ₈ × 44 ³ / ₈	60	61 ³ / ₄ × 63 ³ / ₄ × 66 ¹ / ₄
42	42 ³ / ₈ × 44 ³ / ₈ × 46 ³ / ₈		

**ASME B16.47 SERIES A or
MSS-SP-44 600 LB SPIRAL
WOUND GASKET**

Pipe Size	Gasket Size
22	22 ³ / ₄ × 24 ³ / ₄ × 28 ⁷ / ₈
26	27 × 29 × 34 ¹ / ₈
28	29 × 31 × 36
30	31 ¹ / ₄ × 33 ¹ / ₄ × 38 ¹ / ₄
32	33 ¹ / ₂ × 35 ¹ / ₂ × 40 ¹ / ₄
34	35 ¹ / ₂ × 37 ¹ / ₂ × 42 ¹ / ₄
36	37 ⁵ / ₈ × 39 ⁵ / ₈ × 44 ¹ / ₂
38	39 × 41 × 43 ¹ / ₂
40	41 ¹ / ₄ × 43 ¹ / ₄ × 45 ¹ / ₂
42	43 ¹ / ₂ × 45 ¹ / ₂ × 48

Pipe Size	Gasket Size
44	45 ³ / ₄ × 47 ³ / ₄ × 50
46	47 ³ / ₄ × 49 ³ / ₄ × 52 ¹ / ₄
48	50 × 52 × 54 ¹ / ₄
50	52 × 54 × 57
52	54 × 56 × 59
54	56 ¹ / ₄ × 58 ¹ / ₄ × 61 ¹ / ₄
56	58 ¹ / ₄ × 60 ¹ / ₄ × 63 ¹ / ₂
58	60 ¹ / ₂ × 62 ¹ / ₂ × 65 ¹ / ₂
60	62 ³ / ₄ × 64 ³ / ₄ × 68 ¹ / ₄

**ASME B16.47 SERIES A or
MSS-SP-44 900 LB SPIRAL
WOUND GASKET**

Pipe Size	Gasket Size
22	24 ¹ / ₄ × 27 × 33
26	27 × 29 × 34 ³ / ₄
28	29 × 31 × 37 ¹ / ₄
30	31 ¹ / ₄ × 33 ¹ / ₄ × 39 ³ / ₄
32	33 ¹ / ₂ × 35 ¹ / ₂ × 42 ¹ / ₄
34	35 ¹ / ₂ × 37 ¹ / ₂ × 44 ³ / ₄
36	37 ³ / ₄ × 39 ³ / ₄ × 47 ¹ / ₄

Pipe Size	Gasket Size
38	40 ³ / ₄ × 42 ³ / ₄ × 47 ¹ / ₄
40	43 ¹ / ₄ × 45 ¹ / ₄ × 49 ¹ / ₄
42	45 ¹ / ₄ × 47 ¹ / ₄ × 51 ¹ / ₄
44	47 ¹ / ₂ × 49 ¹ / ₂ × 53 ³ / ₈
46	50 × 52 × 56 ¹ / ₂
48	52 × 54 × 58 ¹ / ₂

NOTE:

ASME B16.20 calls for the use of inner rings on these sizes of 900# gaskets to prevent over-compression damage due to the high available bolt loading. The purchaser should specify the material desired for inner ring construction.

ASME B16.47 SERIES B or API-605 GASKET SIZES

**ASME B16.47 SERIES B or
API-605 150 LB WELD
NECK FLANGE**

Pipe Size	Gasket Size
26	26 ¹ / ₂ × 27 ¹ / ₂ × 28 ⁹ / ₁₆
28	28 ¹ / ₂ × 29 ¹ / ₂ × 30 ⁹ / ₁₆
30	30 ¹ / ₂ × 31 ¹ / ₂ × 32 ⁹ / ₁₆
32	32 ¹ / ₂ × 33 ¹ / ₂ × 34 ¹¹ / ₁₆
34	34 ¹ / ₂ × 35 ³ / ₄ × 36 ¹³ / ₁₆
36	36 ¹ / ₂ × 37 ³ / ₄ × 38 ⁷ / ₈
38	38 ³ / ₈ × 39 ³ / ₄ × 41 ¹ / ₈
40	40 ¹ / ₄ × 41 ⁷ / ₈ × 43 ¹ / ₈
42	42 ¹ / ₂ × 43 ⁷ / ₈ × 45 ¹ / ₈

Pipe Size	Gasket Size
44	44 ¹ / ₄ × 45 ⁷ / ₈ × 47 ¹ / ₈
46	46 ¹ / ₂ × 48 ³ / ₁₆ × 49 ⁷ / ₁₆
48	48 ¹ / ₂ × 50 × 51 ⁷ / ₁₆
50	50 ¹ / ₂ × 52 ³ / ₁₆ × 53 ⁷ / ₁₆
52	52 ¹ / ₂ × 54 ³ / ₁₆ × 55 ⁷ / ₁₆
54	54 ¹ / ₂ × 56 × 57 ⁷ / ₈
56	56 ⁷ / ₈ × 58 ³ / ₁₆ × 59 ⁵ / ₈
58	59 ⁵ / ₆₄ × 60 ³ / ₁₆ × 62 ³ / ₁₆
60	61 ⁵ / ₁₆ × 62 ⁷ / ₁₆ × 64 ³ / ₁₆

RECOMMENDED SIZES FOR LARGE DIAMETER FLANGES

ASME B16.47 SERIES B or API-605 300 LB WELD NECK FLANGE

Pipe Size	Gasket Size	Pipe Size	Gasket Size
26	26½ × 28 × 30¾	44	45¾ × 47¼ × 49¼
28	28½ × 30 × 32½	46	47⅞ × 49⅞ × 51⅞
30	30½ × 32 × 34⅞	48	49¾ × 51⅝ × 53⅞
32	32½ × 34 × 37	50	51⅞ × 53⅞ × 55⅞
34	34½ × 36 × 39⅞	52	53⅞ × 55⅞ × 57⅞
36	36½ × 38 × 41¼	54	55¼ × 57¼ × 60¼
38	39¾ × 41¼ × 43¼	56	58¼ × 60 × 62¾
40	41¼ × 43¼ × 45¼	58	60⅞ × 61⅞ × 65⅞
42	43¾ × 45¼ × 47¼	60	62⅞ × 64⅞ × 67⅞

ASME B16.47 SERIES B or API-605 400 LB WELD NECK FLANGE

Pipe Size	Gasket Size	Pipe Size	Gasket Size
26	26¼ × 27½ × 29¾	44	44½ × 46½ × 48½
28	28⅞ × 29½ × 31½	46	47 × 49 × 50¾
30	30⅞ × 31¾ × 33¾	48	49 × 51 × 53
32	32 × 33⅞ × 35⅞	50	51 × 53 × 55¼
34	34⅞ × 35⅞ × 37⅞	52	53 × 55 × 57¼
36	36⅞ × 38 × 40¼	54	55¼ × 57¼ × 59¾
38	38¼ × 40¼ × 42¼	56	57¼ × 59¼ × 61¾
40	40⅞ × 42⅞ × 44⅞	58	59¼ × 61¼ × 63¾
42	42⅞ × 44⅞ × 46⅞	60	61¾ × 63¾ × 66¼

ASME B16.47 SERIES B or API-605 600 LB WELD NECK FLANGE

Pipe Size	Gasket Size	Pipe Size	Gasket Size
26	26⅞ × 28⅞ × 30⅞	44	45¾ × 47¾ × 50
28	27¾ × 29¾ × 32¼	46	47¾ × 49¾ × 52¼
30	30⅞ × 32⅞ × 34⅞	48	50 × 52 × 54¾
32	32¾ × 34¾ × 36¾	50	52 × 54 × 57
34	35 × 37 × 39¼	52	54 × 56 × 59
36	37 × 39 × 41¼	54	56¼ × 58¼ × 61¼
38	39 × 41 × 43½	56	58¼ × 60¼ × 63½
40	41¼ × 43¼ × 45½	58	60½ × 62½ × 65½
42	43½ × 45½ × 48	60	62¾ × 64¾ × 68¼

ASME B16.47 SERIES B or API-605 900 LB WELD NECK FLANGE

Pipe Size	Gasket Size	Pipe Size	Gasket Size
26	27¼ × 29½ × 33	38	40¾ × 42¾ × 47¼
28	29¼ × 31½ × 35½	40	43¼ × 45¼ × 49¼
30	31¼ × 33¾ × 37¾	42	45¼ × 47¼ × 51¼
32	34 × 36 × 40	44	47½ × 49½ × 53⅞
34	36¼ × 38¼ × 42¼	46	50 × 52 × 56½
36	37¼ × 39¼ × 44¼	48	52 × 54 × 58½

NOTE:

ASME B16.20 calls for the use of inner rings on these sizes of 900# gaskets to prevent over compression damage due to the high available bolt loading. The purchaser should specify the material desired for the inner ring construction.

CLASS 75 LB.

Spiral-Wound Gaskets are not recommended in Class 75 lb. Flanges because the Flanges do not have sufficient bolting strength

CLASS 125 LB. (STEEL) SLIP ON AND WELDING NECK

Applicable for 150 Lb. ANSI and 150 Lb. MSS-SP-44 Taylor Forge Class 125 Tube Turns 125 Lb. PT701 WN and 711 SO Ladish 125 Lb. PT511 AWN and 51214 SO Apply for Flat or Raised Face

Pipe Size	Gasket Size	Pipe Size	Gasket Size
22	22 $\frac{3}{4}$ × 24 × 26	42	42 $\frac{1}{2}$ × 44 $\frac{1}{4}$ × 48
26	26 $\frac{1}{2}$ × 27 $\frac{3}{4}$ × 30 $\frac{1}{2}$	44	44 $\frac{1}{2}$ × 46 $\frac{3}{8}$ × 50 $\frac{1}{4}$
28	28 $\frac{1}{2}$ × 29 $\frac{3}{4}$ × 32 $\frac{3}{4}$	46	46 $\frac{1}{2}$ × 48 $\frac{3}{8}$ × 52 $\frac{1}{4}$
30	30 $\frac{1}{2}$ × 31 $\frac{3}{4}$ × 34 $\frac{3}{4}$	48	48 $\frac{1}{2}$ × 50 $\frac{3}{8}$ × 54 $\frac{1}{2}$
32	32 $\frac{1}{2}$ × 33 $\frac{3}{8}$ × 37	50	50 $\frac{1}{2}$ × 52 $\frac{1}{2}$ × 56 $\frac{1}{2}$
34	34 $\frac{1}{2}$ × 35 $\frac{3}{8}$ × 39	52	52 $\frac{1}{2}$ × 54 $\frac{1}{2}$ × 58 $\frac{3}{4}$
36	36 $\frac{1}{2}$ × 38 $\frac{3}{8}$ × 41 $\frac{1}{4}$	54	54 $\frac{1}{2}$ × 56 $\frac{1}{2}$ × 61
38	38 $\frac{1}{2}$ × 40 $\frac{3}{8}$ × 43 $\frac{3}{4}$	60	60 $\frac{1}{2}$ × 62 $\frac{1}{2}$ × 67 $\frac{1}{2}$
40	40 $\frac{1}{2}$ × 42 $\frac{3}{8}$ × 45 $\frac{3}{4}$		

CLASS 175

Taylor Forge 175 Welding Neck or Slip-On Tube Turns 150 Lb., Tube Turn Class 175 Welding Neck PT 703 Only Ladish 150 Lb. Parts 505 (WN) and 506 (SO) Not Applicable for Tube Turn Class 175 Slip-On PT 713 Which Have Larger Bolt Circles

Pipe Size	Gasket Size	Pipe Size	Gasket Size
26	26 $\frac{1}{2}$ × 27 $\frac{3}{4}$ × 29 $\frac{1}{8}$	42	42 $\frac{1}{2}$ × 44 × 45 $\frac{7}{8}$
28	28 $\frac{1}{2}$ × 29 $\frac{3}{4}$ × 31 $\frac{1}{8}$	44	44 $\frac{1}{2}$ × 46 × 47 $\frac{7}{8}$
30	30 $\frac{1}{2}$ × 31 $\frac{3}{4}$ × 33 $\frac{3}{8}$	46	46 $\frac{1}{2}$ × 48 × 49 $\frac{7}{8}$
32	32 $\frac{1}{2}$ × 33 $\frac{3}{4}$ × 35 $\frac{3}{8}$	48	48 $\frac{1}{2}$ × 50 $\frac{3}{8}$ × 51 $\frac{7}{8}$
34	34 $\frac{1}{2}$ × 35 $\frac{3}{8}$ × 37 $\frac{1}{2}$	50	50 $\frac{1}{2}$ × 52 $\frac{1}{4}$ × 53 $\frac{7}{8}$
36	36 $\frac{1}{2}$ × 37 $\frac{3}{8}$ × 39 $\frac{1}{2}$	52	52 $\frac{1}{2}$ × 54 $\frac{3}{8}$ × 56 $\frac{1}{8}$
38	38 $\frac{1}{2}$ × 39 $\frac{3}{8}$ × 41 $\frac{1}{2}$	54	54 $\frac{1}{2}$ × 56 $\frac{3}{8}$ × 58 $\frac{1}{8}$
40	40 $\frac{1}{2}$ × 42 × 43 $\frac{1}{2}$	60	60 $\frac{1}{2}$ × 62 $\frac{1}{2}$ × 64 $\frac{1}{8}$

CLASS 250 LB. (STEEL)

Taylor Forge Class 250 Tube Turns 250 Lb. PTS 702 (WN) and 712 (SO) Ladish 250 Lbs. PTS 513 (WN) and 514A (SO) Gaskets Applicable for Flat or Raised Faces

Pipe Size	Gasket Size	Pipe Size	Gasket Size
26	26 $\frac{1}{2}$ × 27 $\frac{3}{4}$ × 32 $\frac{3}{4}$	38	38 $\frac{1}{2}$ × 40 $\frac{3}{8}$ × 46
28	28 $\frac{1}{2}$ × 29 $\frac{3}{4}$ × 35 $\frac{1}{4}$	40	40 $\frac{1}{2}$ × 42 $\frac{3}{8}$ × 48 $\frac{1}{4}$
30	30 $\frac{1}{2}$ × 31 $\frac{3}{4}$ × 37 $\frac{1}{2}$	42	42 $\frac{1}{2}$ × 44 $\frac{1}{4}$ × 50 $\frac{3}{4}$
32	32 $\frac{1}{2}$ × 33 $\frac{3}{8}$ × 39 $\frac{3}{4}$	44	44 $\frac{1}{2}$ × 46 $\frac{3}{8}$ × 53
34	34 $\frac{1}{2}$ × 35 $\frac{3}{8}$ × 41 $\frac{3}{4}$	46	46 $\frac{1}{2}$ × 48 $\frac{3}{8}$ × 55 $\frac{1}{4}$
36	36 $\frac{1}{2}$ × 38 $\frac{3}{8}$ × 44	48	48 $\frac{1}{2}$ × 50 $\frac{3}{8}$ × 58 $\frac{3}{4}$

CLASS 350 LB. SLIP ON AND WELDING NECK

Taylor Forge Class 350 Welding Neck and Slip-On Tube Turns 300 Lb. WN and SO Tube Turns Class 350 WN PT 705 Ladish 300 lb. PTS 508 (WN) and 509 (SO) Not Applicable for Tube Turns Class 350 Slip-On PT 714 Which Have Larger Diameter Bolt Circles

Pipe Size	Gasket Size	Pipe Size	Gasket Size
26	26 $\frac{1}{2}$ × 27 $\frac{3}{4}$ × 29 $\frac{3}{8}$	42	42 $\frac{1}{2}$ × 44 $\frac{1}{4}$ × 46 $\frac{3}{8}$
28	28 $\frac{1}{2}$ × 29 $\frac{3}{4}$ × 31 $\frac{3}{8}$	44	44 $\frac{1}{2}$ × 46 $\frac{3}{8}$ × 49
30	30 $\frac{1}{2}$ × 31 $\frac{3}{4}$ × 33 $\frac{3}{8}$	46	46 $\frac{1}{2}$ × 48 $\frac{3}{8}$ × 51
32	32 $\frac{1}{2}$ × 33 $\frac{3}{8}$ × 35 $\frac{3}{8}$	48	48 $\frac{1}{2}$ × 50 $\frac{3}{8}$ × 53
34	34 $\frac{1}{2}$ × 35 $\frac{3}{8}$ × 37 $\frac{3}{8}$	52	52 $\frac{1}{2}$ × 54 $\frac{1}{4}$ × 57 $\frac{3}{8}$
36	36 $\frac{1}{2}$ × 38 $\frac{3}{8}$ × 40 $\frac{3}{8}$	54	54 $\frac{1}{2}$ × 56 $\frac{1}{2}$ × 59 $\frac{3}{8}$
38	38 $\frac{1}{2}$ × 40 $\frac{3}{8}$ × 42 $\frac{3}{8}$	60	60 $\frac{1}{2}$ × 62 $\frac{1}{2}$ × 65 $\frac{3}{8}$
40	40 $\frac{1}{2}$ × 42 $\frac{3}{8}$ × 44 $\frac{3}{8}$	66	66 $\frac{1}{2}$ × 68 $\frac{1}{2}$ × 72 $\frac{1}{2}$

LAMONS SPIRASEAL STYLE W GASKETS

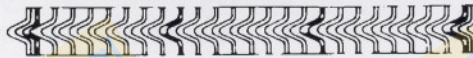

Style W gaskets are SpiraSeal windings only, no inner or outer rings. Used in thousands of different applications, they may be furnished in many different sizes and thicknesses.

Style W gaskets are made in standard sizes to fit:

- Large tongue and groove joints, 1/2" thru 24" NPS, standard pressures
- Small tongue and groove joints, 1/2" thru 24" NPS, standard pressures
- Large male and female joints 1/4" thru 24" NPS, standard pressures

SIZING SPIRAL WOUND GASKETS

Spiral-wound gaskets must be sized to ensure the spiral-wound component is seated between flat surfaces. If it protrudes beyond a raised face or into a flange bore, mechanical damage and leakage may occur.

GASKET CONFINED ON I.D. AND O.D.

Gasket I.D. = Groove I.D. + 1/16"
Gasket O.D. = Groove O.D. - 1/16"

GASKET CONFINED ON O.D. ONLY

Gasket I.D. = Bore + Minimum 1/4"
Gasket O.D. = Recess O.D. - 1/16"

GASKET UNCONFINED ON I.D. AND O.D.

Gasket I.D. = Seating Surface I.D. + Minimum 1/4"
Gasket O.D. = Seating Surface O.D. - Minimum 1/4"
Centering Guide O.D. = Bolt Circle Diameter - Diameter of Bolt

LIMITATION OF SIZE AND THICKNESS

Gasket Thickness	Max. I.D.*	Recommended Compressed Thickness
.0625"	9"	.050"/.055"
.125"	40"	.090"/.100"
.175"	75"	.125"/.135"
.250"	160"	.180"/.200"
.285"	160"	.200"/.220"

*Maximum sizes are intended as a general guide. In certain cases they may be exceeded, however as a gasket approaches (or exceeds) I.D. limits it becomes increasingly unstable. The width of the winding and the materials specified for construction also effect the I.D. limits.

STANDARD TOLERANCES

Gasket Diameter	I.D.	O.D.
Up to 1"	+3/64 -0	+0 -1/32
1" to 24"	+1/32 -0	+0 -1/32
24" to 36"	+3/64 -0	+0 -1/16
36" to 60"	+1/16 -0	+0 -1/16
60" and above	+3/32 -0	+0 -3/32

Thickness + .015 - .000 on special Gaskets with:

- less than 1" I.D., greater than 26" I.D.
- teflon fillers
- 1" or larger flange width

Thickness + .010 - .000 for most other sizes and materials.

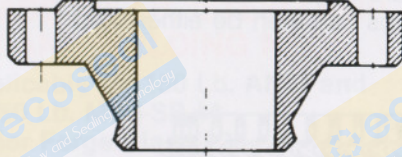
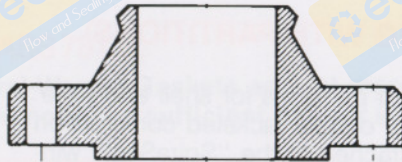

Large Male and Female Joint



Raised Face Flange



Large Tongue and Groove Joint

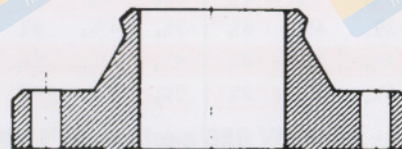

Small Tongue and Groove Joint

FOR LARGE MALE AND FEMALE JOINTS

Nominal Pipe Size Inches	150, 300, 400, 600 lb.		900, 1500 lb.		2500 lb.	
	I.D. Inches	O.D. Inches	I.D. Inches	O.D. Inches	I.D. Inches	O.D. Inches
1/4	1/2	1	—	—	—	—
1/2	1	1 3/8	1	1 3/8	1 1/16	1 3/8
3/4	1 1/16	1 11/16	1 1/16	1 11/16	1 1/16	1 11/16
1	1 1/2	2	1 1/2	2	1 1/4	2
1 1/4	1 7/8	2 1/2	1 7/8	2 1/2	1 5/8	2 1/2
1 1/2	2 1/8	2 7/8	2 1/8	2 7/8	1 7/8	2 7/8
2	2 7/8	3 5/8	2 7/8	3 5/8	2 3/8	3 5/8
2 1/2	3 3/8	4 1/8	3 3/8	4 1/8	3	4 1/8
3	4 1/4	5	4 1/4	5	3 3/4	5
3 1/2	4 3/4	5 1/2	4 3/4	5 1/2	—	—
4	5 3/16	6 3/16	5 3/16	6 3/16	4 3/4	6 3/16
4 1/2	5 11/16	6 3/4	—	—	—	—
5	6 3/16	7 1/16	6 3/16	7 1/16	5 3/4	7 1/16
6	7 1/2	8 1/2	7 1/2	8 1/2	6 3/4	8 1/2
8	9 3/8	10 5/8	9 3/8	10 5/8	8 3/4	10 5/8
10	11 1/4	12 3/4	11 1/4	12 3/4	10 3/4	12 3/4
12	13 1/2	15	13 1/2	15	13	15
14	14 3/4	16 1/4	14 3/4	16 1/4	—	—
16	17	18 1/2	17	18 1/2	—	—
18	19 1/4	21	19 1/4	21	—	—
20	21	23	21	23	—	—
24	25 1/4	27 1/4	25 1/4	27 1/4	—	—

FOR LARGE TONGUE AND GROOVE JOINTS

Nominal Pipe Size Inches	150-2500 Lb. Inclusive*	
	I.D. Inches	O.D. Inches
1/2	1	1 3/8
3/4	1 5/16	1 11/16
1	1 1/2	2
1 1/4	1 7/8	2 1/2
1 1/2	2 1/8	2 7/8
2	2 7/8	3 5/8
2 1/2	3 3/8	4 1/8
3	4 1/4	5
3 1/2	4 3/4	5 1/2
4	5 3/16	6 3/16
5	6 3/16	7 1/16
6	7 1/2	8 1/2
8	9 3/8	10 5/8
10	11 1/4	12 3/4
12	13 1/2	15
14	14 3/4	16 1/4
16	16 3/4	18 1/2
18	19 1/4	21
20	21	23
24	25 1/4	27 1/4

FOR SMALL TONGUE AND GROOVE JOINTS

Nominal Pipe Size Inches	150-2500 Lb. Inclusive	
	I.D. Inches	O.D. Inches
1/2	1	1 3/8
3/4	1 5/16	1 11/16
1	1 1/2	1 7/8
1 1/4	1 7/8	2 1/4
1 1/2	2 1/8	2 1/2
2	2 7/8	3 1/4
2 1/2	3 3/8	3 3/4
3	4 1/4	4 5/8
3 1/2	4 3/4	5 1/8
4	5 3/16	5 11/16
5	6 3/16	6 3/16
6	7 1/2	8
8	9 3/8	10
10	11 1/4	12
12	13 1/2	14 1/4
14	14 3/4	15 1/2
16	16 3/4	17 3/8
18	19 1/4	20 1/8
20	21	22
24	25 1/4	26 1/4

*2500 # thru 12" size only

Note: Consult Lamons Technical Department when solid metal inner rings are required.

SPIRASEAL STYLE WP, WRP, AND WR-RJ GASKETS

WP OR WRP GASKETS (WINDING WITH PARTITIONS)



"SpiraSeal" gaskets may be furnished with partitions for shell and tube heat exchangers. Partitions are normally of double jacketed construction (same metal as winding). Partitions are attached to the "SpiraSeal" winding with silver solder. In some cases, there may be a solid metal inner ring installed in the gasket; the partition ribs can then be either solid metal or double jacketed.

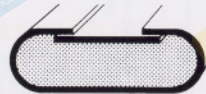

Rib Cross Section



Winding Cross Section

Accurately made to close tolerances, these gaskets are a Lamons specialty. We welcome your inquiry on any size.

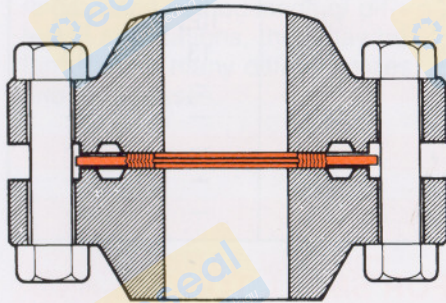

DIMENSIONS OF WR-RJ GASKETS

These SpiraSeal gaskets are available to replace oval or octagonal metal gaskets in ring-joint flange connections. Only $\frac{1}{16}$ " breakaway of flange faces is required to replace the WR-RJ gasket, compared to $\frac{1}{2}$ " to $\frac{3}{4}$ " required with conventional ring gaskets; therefore, WR-RJ gaskets are replaced easier and quicker, especially where there is close manifolding of the piping.

Note: These are not stock items, but are available on special order.
 Note: "Please contact Lamons Technical Department to determine if gasket is appropriate for flange bore size. In some cases, special inner rings are also suggested (WRI-RJ)".

Nom. Pipe Size	150 PSI			300 PSI			400 PSI			600 PSI			900 PSI			1500 PSI		
	Gasket I.D.	Gasket O.D.	Ring O.D.	Gasket I.D.	Gasket O.D.	Ring O.D.	Gasket I.D.	Gasket O.D.	Ring O.D.	Gasket I.D.	Gasket O.D.	Ring O.D.	Gasket I.D.	Gasket O.D.	Ring O.D.	Gasket I.D.	Gasket O.D.	Ring O.D.
1/2	—	—	—	9/16	15/16	2 1/8	9/16	15/16	2 1/8	9/16	15/16	2 1/8	9/16	1 1/16	2 1/2	9/16	1 1/16	2 1/2
3/4	—	—	—	13/16	1 1/4	2 5/8	13/16	1 1/4	2 5/8	13/16	1 1/4	2 5/8	13/16	1 5/16	2 3/4	13/16	1 5/16	2 3/4
1	—	—	—	1 1/16	1 9/16	2 7/8	1 1/16	1 9/16	2 7/8	1 1/16	1 9/16	2 7/8	1 1/16	1 9/16	3 1/8	1 1/16	1 9/16	3 1/8
1 1/4	1 3/8	1 13/16	3	1 5/16	1 7/8	3 1/4	1 5/16	1 7/8	3 1/4	1 5/16	1 7/8	3 1/4	1 5/16	1 11/16	3 1/2	1 5/16	1 11/16	3 1/2
1 1/2	1 5/8	2 1/8	3 3/8	1 9/16	2 3/16	3 3/4	1 9/16	2 3/16	3 3/4	1 9/16	2 3/16	3 3/4	1 9/16	2 1/4	3 7/8	1 9/16	2 1/4	3 7/8
2	2 1/8	2 3/4	4 1/8	2 1/8	2 11/16	4 3/8	2 1/8	2 11/16	4 3/8	2 1/8	2 11/16	4 3/8	2 1/8	3 3/16	5 1/8	2 1/8	3 3/16	5 1/8
2 1/2	2 3/4	3 5/16	4 7/8	2 3/4	3 5/16	5 1/8	2 3/4	3 5/16	5 1/8	2 3/4	3 5/16	5 1/8	2 3/4	3 3/8	6 1/2	2 3/4	3 5/16	6 1/2
3	3 3/16	3 1 1/16	5 3/8	3 3/16	3 1 1/16	5 7/8	3 3/16	3 1 1/16	5 7/8	3 3/16	3 1 1/16	5 7/8	3 3/16	4 3/16	6 5/8	3 3/16	4 1 1/16	6 5/8
4	4 3/16	5 3/16	6 7/8	4 3/16	5 3/16	7 1/8	4 3/16	5 3/16	7	4 3/16	5 3/16	7 3/8	4 3/16	5 3/16	8 1/8	4 3/16	5 1 1/16	8 1/8
5	5 3/16	6 3/16	7 3/4	5 3/16	6 3/16	8 1/2	5 3/16	6 3/16	8 3/8	5 3/16	6 3/16	9 1/2	5 3/16	6 3/16	9 3/4	5 3/16	6 3/16	10
6	6 3/16	7 3/16	8 3/4	6 3/16	7 3/16	9 3/8	6 3/16	7 3/16	9 3/4	6 3/16	7 3/16	10 1/2	6 3/16	7 3/16	11 3/8	6	7 3/16	11 3/8
8	8 1/4	9 3/16	11	8 1/4	9 1 1/16	12 3/8	8 1/4	9 1 1/16	12	8 1/4	9 1 1/16	12 3/8	8 1/4	9 1 1/16	14 1/8	7 7/8	9 3/4	13 7/8
10	10 3/16	11 3/16	13 3/8	10 3/16	12	14 1/4	10 3/16	12	14 1/8	10 3/16	12	15 3/4	10 3/16	12	17 1/8	9 9/16	11 3/8	17 3/8
12	12 3/16	13 3/16	16 3/8	12 3/16	14 1/4	16 3/4	12 3/16	14 1/4	16 1/2	12 3/16	14 1/4	18	12 3/16	14 1/4	19 3/8	11 3/16	13 3/16	20 1/2
14	13 3/16	14 3/16	17 3/4	14 1/4	15 3/4	19 3/8	14 1/4	15 3/4	19	14 1/4	15 3/4	19 3/8	13 3/16	15 3/16	20 1/2	13 3/16	15 3/16	22 3/4
16	15 3/16	16 3/16	20 1/4	16 3/4	17 3/4	21 1/4	16 3/4	17 3/4	21 3/8	16 3/4	17 3/4	22 1/4	15 3/16	17 3/16	22 3/8	15	17	25 1/4
18	17 1/4	19	21 3/8	18 1/4	20 1/4	23 1/2	18 1/4	20 1/4	23 3/8	18 1/4	20 1/4	24 3/8	17 1 1/16	19 1 1/16	25 1/8	17 1/4	19 1/2	27 3/4
20	19 3/8	21 3/8	23 3/8	20 3/4	22 3/8	25 3/4	20 3/4	22 3/8	25 1/2	20 3/4	22 3/8	26 3/8	19 1 1/16	21 1 1/16	27 1/2	19 3/8	21 3/8	29 3/4
24	23	25 1/4	28 1/2	24 1/4	26 3/8	30 1/2	24 1/4	26 3/8	30 3/4	24 1/4	26 3/8	31 3/8	23 3/16	25 3/16	33	23	25 1/2	35 1/2

* * For this size Lamons Technical Department should be consulted.

LAMONS STYLE WRI GASKETS

STANDARD INNER-RING INSIDE DIAMETERS FOR SPIRAL-WOUND GASKETS (INCHES)

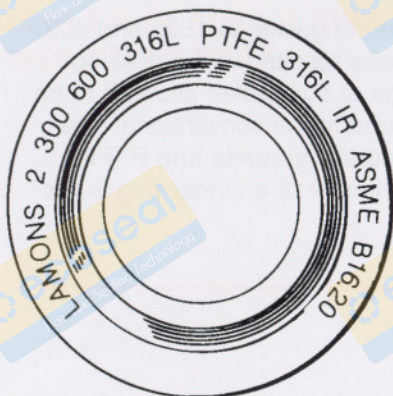

WRI GASKETS

The Style WRI gasket has both a solid inner and outer metal ring. The inner ring prevents inward distortion of the "SpiraSeal" element and fills the void between flanges from the "SpiraSeal" element to the bore of the flange. Generally, the inner ring material is the same as the winding metal.

Note: These are not stock items, but are available on special order.

Flange Size (NPS)	Pressure Class						
	150	300	400	600	900	1500	2500
1/2	0.56	0.56	(1)	0.56	(1)	0.56	0.56
3/4	0.81	0.81	(1)	0.81	(1)	0.81	0.81
1	1.06	1.06	(1)	1.06	(1)	1.06	1.06
1 1/4	1.50	1.50	(1)	1.50	(1)	1.31 (2)	1.31 (2)
1 1/2	1.75	1.75	(1)	1.75	(1)	1.63 (2)	1.63 (2)
2	2.19	2.19	(1)	2.19	(1)	2.06 (2)	2.06 (2)
2 1/2	2.62	2.62	(1)	2.62	(1)	2.50 (2)	2.50 (2)
3	3.19	3.19	(1)	3.10	3.10	3.10	3.10
4	4.19	4.19	4.04	4.04	4.04	3.85	3.85 (3)
5	5.19	5.19	5.05	5.05	5.05	4.90	4.90 (3)
6	6.19	6.19	6.10	6.10	6.10	5.80	5.80 (3)
8	8.50	8.50	8.10	8.10	7.75	7.75	7.75 (3)
10	10.56	10.56	10.05	10.05	9.69	9.69	9.69 (3)
12	12.50	12.50	12.10	12.10	11.50	11.50 (3)	11.50 (3)
14	13.75	13.75	13.50	13.50	12.63	12.63 (3)	(1)
16	15.75	15.75	15.35	15.35	14.75	14.50 (3)	(1)
18	17.69	17.69	17.25	17.25	16.75	16.75 (3)	(1)
20	19.69	19.69	19.25	19.25	19.00	18.75 (3)	(1)
24	23.75	23.75	23.25	23.25	23.25 (3)	22.75 (3)	(1)

GENERAL NOTES:

- (A) The inner ring thickness shall be 0.117-0.131 in.
- (B) For sizes NPS 1 1/4 through NPS 3, the inside diameter tolerance is ± 0.03 in.; for larger sizes the inside diameter tolerance is ± 0.06 in. See Table 13 for minimum pipe wall thicknesses that are suitable for use with standard inner rings.

NOTES:

- (1) There are no Class 400 flanges NPS 1/2 through NPS 3 (use Class 600), Class 900 flanges NPS 1/2 through NPS 2 1/2 (use Class 1500), or Class 2500 flanges NPS 14 and larger.
- (2) The inner ring inside diameters shown for NPS 1 1/4 through NPs 2 1/2 in Class 1500 and 2500 will produce inner ring widths of 0.12 in., a practical minimum for production purposes.
- (3) Inner rings are required for Class 900, NPS 24 gaskets; Class 1500, NPS 12 through NPS 24 gaskets; and Class 2500, NPS 4 through NPS 12 gaskets.

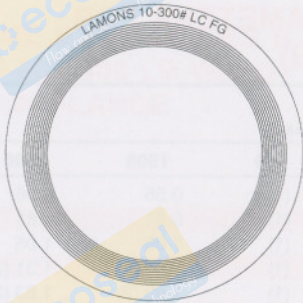

STYLE, WR-LC

The need for a low compressive load spiral wound gasket in 150# and 300# class ASME/ANSI B16.5 pipe flange applications resulted in the development of the “WR-LC” spiral wound. The design of our gasket allows it to be compressed with less bolt load to seat compared to the conventional type spirals. The soft filler materials commonly used are graphite and PTFE. When selecting PTFE for your filler material the use of an inner ring is recommended (style WRI-LC).



WRI HF GASKETS

This gasket was developed for H.F. acid applications. It consists of a Monel and PTFE spiral wound gasket with a carbon steel centering ring and a PTFE inner ring. The carbon steel outer ring can be coated with special H.F. acid detecting paint if desired. The PTFE inner ring reduces corrosion to the flanges between the bore of the pipe and the I.D. of the spiral wound sealing element. Inner ring I.D.'s are the same as standard metal inner rings unless otherwise requested. Thickness of the PTFE inner ring is .150 ±.005 normally.

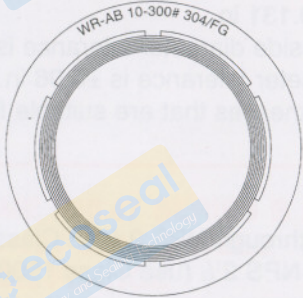

STYLE, WR-AB

Spiral wounds that inwardly buckle are a concern in the industry and Lamons has introduced a spiral wound that addresses this historical concern. The traditional method to reduce inward buckling is to order an inner ring and that is still the best practice today. Lamons has a new style spiral called “WR-AB” that does not require an inner ring. There are many additional advantageous design features to this product to reduce inward buckling. (Contact Lamons' Technical Department regarding flange bore sizes for which this gasket may or may not be appropriate.)

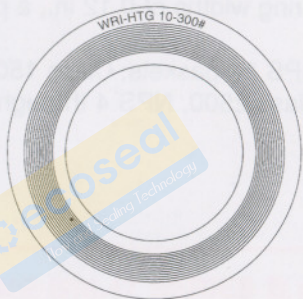

STYLE, WRI-HTG

For applications requiring a spiral wound when oxidation may occur, usually at higher temperatures, Lamons has developed the “WRI-HTG”. This gasket combines the **corrosion and oxidation resistance of mica** with the **excellent sealability of flexible graphite**. The mica along with the metal winding serves as a barrier between oxidizing process conditions and the external air and the graphite. This gasket can be ordered for any ASME/ANSI B16.5 and ASME B16.47 series A or B flange or for special applications

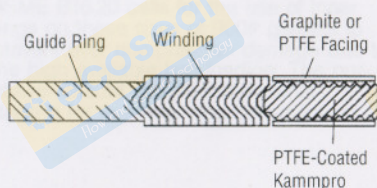

WRI-LP

A Spiralwound gasket with a conventional outer guide ring with a special inner ring design. This special inner ring design is our “Kammpro” profile style LP-1. The uniqueness of the “kammpro” design allows numerous choices on its construction. The “WRI-LP” allows the spiral winding to be constructed with the required metal and soft filler specified by the user. The “Kammpro” inner ring metal can be ordered with or without PTFE coating and then faced with either .020” thick PTFE, graphite or other materials.

**STANDARD INNER-RING INSIDE
DIAMETERS FOR SPIRAL-WOUND GASKETS USED
BETWEEN ASME B16.47 SERIES A or MSS SP-44 FLANGES**

Flange Size (NPS)	Pressure Class				
	150	300	400	600	900
26	25.75	25.75	26.00	25.50	26.00 (1)
28	27.75	27.75	28.00	27.50	28.00 (1)
30	29.75	29.75	29.75	29.75	30.25 (1)
32	31.75	31.75	32.00	32.00	32.00 (1)
34	33.75	33.75	34.00	34.00	34.00 (1)
36	35.75	35.75	36.13	36.13	36.25 (1)
38	37.75	37.50	37.50	37.50	39.75 (1)
40	39.75	39.50	39.38	39.75	41.75 (1)
42	41.75	41.50	41.38	42.00	43.75 (1)
44	43.75	43.50	43.50	43.75	45.50 (1)
46	45.75	45.38	46.00	45.75	48.00 (1)
48	47.75	47.63	47.50	48.00	50.00 (1)
50	49.75	49.00	49.50	50.00	(2)
52	51.75	52.00	51.50	52.00	(2)
54	53.50	53.25	53.25	54.25	(2)
56	55.50	55.25	55.25	56.25	(2)
58	57.50	57.00	57.25	58.00	(2)
60	59.50	60.00	59.75	60.25	(2)

GENERAL NOTES:

- (A) The inner ring thickness shall be 0.117–0.131 in.
- (B) The inside diameter tolerance is ± 0.12 in.
- (C) These inner rings are suitable for use with pipe walls 0.38 in. or thicker.

NOTES:

- (1) Inner rings are required for Class 900 gaskets.
- (2) There are no Class 900 flanges NPS 50 and larger.

**STANDARD INNER-RING INSIDE DIAMETERS FOR
SPIRAL-WOUND GASKETS USED BETWEEN
ASME B16.47 SERIES B or API 605 FLANGES**

Flange Size (NPS)	Pressure Class				
	150	300	400	600	900
26	25.75	25.75	25.75	25.38	26.25 (1)
28	27.75	27.75	27.63	27.00	28.25 (1)
30	29.75	29.75	29.63	29.63	30.75 (1)
32	31.75	31.75	31.50	31.25	33.00 (1)
34	33.75	33.75	33.50	33.50	35.25 (1)
36	35.75	35.75	35.38	35.50	36.25 (1)
38	37.75	38.25	37.50	37.50	39.75 (1)
40	39.75	40.25	39.38	39.75	41.75 (1)
42	41.75	42.75	41.38	42.00	43.75 (1)
44	43.75	44.25	43.50	43.75	45.50 (1)
46	45.75	46.38	46.00	45.75	48.00 (1)
48	47.75	48.50	47.50	48.00	50.00 (1)
50	49.75	49.88	49.50	50.00	(2)
52	51.75	51.88	51.50	52.00	(2)
54	53.75	53.75	53.25	54.25	(2)
56	56.00	56.25	55.25	56.25	(2)
58	58.19	58.44	57.25	58.00	(2)
60	60.44	61.31	59.75	60.25	(2)

GENERAL NOTES:

- (A) The inner ring thickness shall be 0.117–0.131 in.
- (B) The inside diameter tolerance is ± 0.12 in.
- (C) These inner rings are suitable for use with pipe walls 0.38 in. or thicker.

NOTES:

- (1) Inner rings are required for Class 900 gaskets.
- (2) There are no Class 900 flanges NPS 50 and larger.

LAMONS MW, MWC & MWI GASKETS

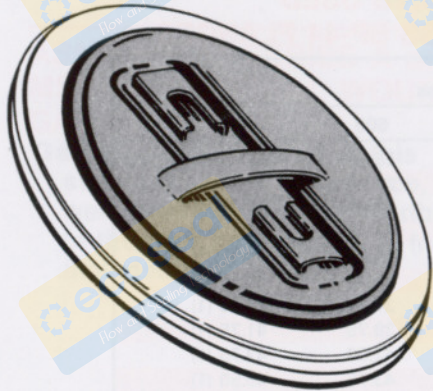

Round



Obround

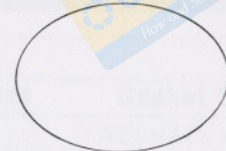

Oval

MW & MWC GASKETS (FOR MANWAY ASSEMBLIES)

Designed for standard manhole cover assemblies, these gaskets:

- a. Provide for adequate compression factors within the defined limits of service pressure ratings
- b. Compensate for rough or worn seating surfaces

"SpiraSeal" Style MW & MWC Gaskets are available in a wide variety of designs to meet specific requirements. They are manufactured in three ranges of operating pressures and for almost all makes of boilers and auxiliary equipment:

- 0 - 499 lbs.
- 0 - 999 lbs.
- 1000 lbs. and above

They are available in thicknesses of .175" or .250"; flange width of 1 1/4", 1 3/16", 1 5/16" or 1 3/4", and either oval, obround or round in shape.

"SpiraSeal" Style MW Gaskets, manufactured of Type 304 Stainless Steel and Chlorocarb* are used for 0-999 and 1000-up pressure ranges and will be furnished unless otherwise specified. Low Carbon steel and Chlorocarb* are used for low pressure 0-499 lb. operations. Other types of stainless steel and alloys are used where corrosive acid, alkalis or other conditions indicate. Grafoil* is also a common filler specified in place of Chlorocarb*.

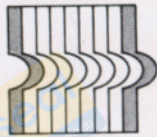

MW

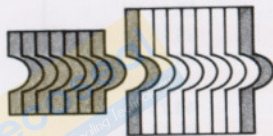

MWC



MWI

STYLE MW & MWC GASKETS FOR MANHOLE COVER ASSEMBLIES

Style	Shape	Nominal I.D. Dimensions (Inches)	Thickness (Inches)	Flange Width (Inches)
MW	Oval	10 x 15	.250	1 5/16
MW	Oval	10 x 16	.250	1 5/16
MW	Oval	11 x 15	.250	1 5/16
MW	Oval	11 x 15	.250	1 1/4
MWC	Oval	11 x 15	.250	1 3/16
MW	Oval	11 x 15	.175	1 1/2
MW	Oval	11 x 15	.175	3/4
MW	Oval	11 x 15	.175	1 5/16
MW	Oval	11 x 15	.175	1 1/4
MW	Obround	11 1/16 x 14 7/8	.250	1 5/16
MW	Obround	11 7/16 x 15 1/16	.250	1 5/16
MW	Oval	12 x 16	.250	1 5/16
MW	Oval	12 x 16	.250	1 1/4
MWC	Oval	12 x 16	.250	1 3/16
MW	Oval	12 x 16	.175	1 1/2
MW	Oval	12 x 16	.175	3/4
MW	Oval	12 x 16	.175	1 5/16
MW	Oval	12 x 16	.175	1 1/4
MWC	Oval	12 1/8 x 16 1/8	.250	1 3/16
MW	Obround	14 x 16	.175	3/4
MW	Round	14	.175	3/4
MW	Round	16 1/16	.175	3/4

Style MWI manway gaskets consist of a winding with a solid metal inner ring to position the winding and help avoid mechanical damage. Contact Lamons technical staff for assistance.

LAMONS SPIRASEAL STYLE H GASKETS

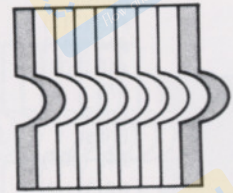
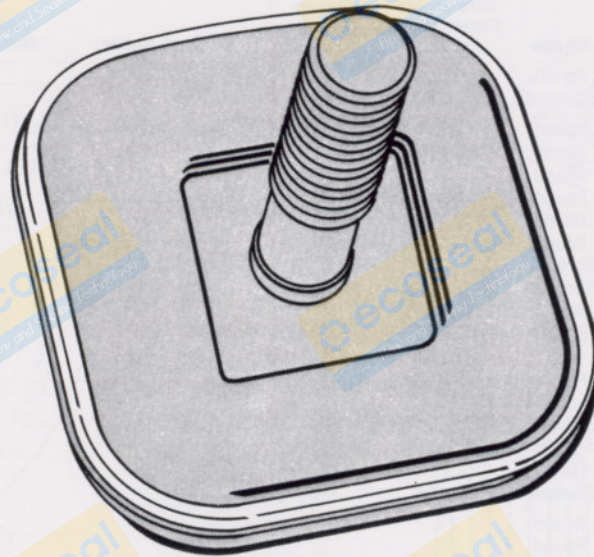

Round



**Square
or
Rectangular**

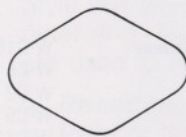

Diamond



**Obround or Flat-Sided
or
Straight-Sided**

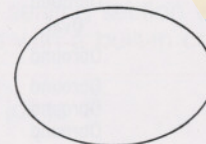

Oval

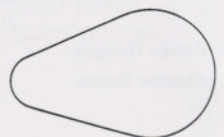

Pear

STYLE H GASKETS (FOR HANDHOLES)

For boiler handhole and tubecap assemblies, these gaskets:

- Maintain a seal with a minimum of maintenance cost
- Require no sealing compounds.
- Recover under loss of compression.

QUALITY, SAFETY AND ECONOMY

Quality, safety and economy are combined in "SpiraSeal" Style H Gaskets. Their resilient, spiral wound construction assures consistent high performance, even under continuous or fluctuating loads. They are manufactured for three ranges of operating pressures:

- 0 - 499 lbs.
- 0 - 999 lbs.
- 1000 lbs. and above

Type 304 Stainless Steel and Chlorocarb® are used for 0-999 and 1000-up pressure ranges and will be furnished unless otherwise specified. Low Carbon Steel and Chlorocarb® are used for low pressure 0-499 lb. operations. Other types of stainless steel and alloys are used where corrosive acid, alkalis or other conditions indicate. Grafoil® is also a common filler specified in place of Chlorocarb®

Standard "SpiraSeal" Style H Gaskets are manufactured to nominal original thicknesses of .175". Special gaskets with a thickness of .125 or .250" are also available.

Complete and accurate data should be furnished when ordering "SpiraSeal" Style H gaskets. Special designs for non-standard handhole and tubecap assemblies are available. When ordering special, non-standard handhole gaskets, be sure to include all available data; i.e., operating temperature and pressure, dimensions or sketch, gasket materials, flange seating width, and so forth.

STANDARD HANDHOLE AND TUBECAP SIZES OF VARIOUS BOILERS

Make of Boiler	Gasket Number	Shape	Nominal Size Inside Dimensions (Inches)	Flange Width (Inches)
American Engr.		Round	3 ¹ / ₁₆	3 ¹ / ₁₆
		Obround	3 ⁵ / ₁₆ × 3 ¹ / ₁₆	3 ¹ / ₁₆
Babcock & Wilcox	#2 Econ	Round	1 ⁵ / ₈	1 ¹ / ₄
	#47	Round	2 ¹ / ₃₂	3 ¹ / ₁₆
	#32	Round	3	1 ¹ / ₄
	#70	Round	3 ⁹ / ₃₂	3 ¹ / ₁₆
	#89	Round	3 ⁷ / ₁₆	5 ¹ / ₃₂
	#92	Round	4 ¹ / ₃₂	1 ¹ / ₄
	#41 (203)	Obround	2 ⁹ / ₁₆₄ × 2 ³ / ₁₆₄	5 ¹ / ₃₂
	#79	Obround	4 ⁵ / ₃₂ × 4 ² / ₃₂	1 ¹ / ₄
	British	Square	3 ² / ₃₂ × 3 ² / ₃₂	7 ¹ / ₃₂
	British	Square	4 ³ / ₄ × 4 ³ / ₄	7 ¹ / ₃₂
	#28 (212)	Rect.	4 ¹ / ₁₆ × 5	7 ¹ / ₃₂
	#24 (211)	Oval	4 ¹ / ₂ × 5 ¹ / ₂	7 ¹ / ₃₂
	#48 (208)	Oval	3 ¹ / ₁₆ × 4 ³ / ₄	7 ¹ / ₃₂
	#76	Oval	5 ¹ / ₃₂ × 5 ¹ / ₃₂	1 ¹ / ₄
	British	Oval	3 ¹ / ₃₂ × 3 ² / ₃₂	3 ¹ / ₁₆
	British	Oval	4 ³ / ₃₂ × 4 ² / ₃₂	1 ¹ / ₄
	#40 (207)	Diamond	3 ³ / ₈ × 3 ³ / ₄	3 ¹ / ₁₆
Bros	HB-5, HB-10	Round	2 ¹ / ₄	1 ¹ / ₄
	HB-6, HB-11	Round	3 ³ / ₈	1 ¹ / ₄
	HB-12	Round	4 ¹ / ₄	1 ¹ / ₄
	HB-8, HB-13	Obround	3 ³ / ₈ × 4 ¹ / ₄	1 ¹ / ₄
	HB-14	Obround	4 ¹ / ₄ × 5	1 ¹ / ₄
Bucyrus-Erie	Q208	Round	2 ¹ / ₂	1 ¹ / ₄
	Q227	Obround	3 × 4 ¹ / ₂	3 ³ / ₈
	Q260	Oval	4 × 6	7 ¹ / ₁₆
Casey Hedges		Obround	4 ¹ / ₄ × 5 ¹ / ₈	3 ³ / ₈
Cleaver Brook		Obround	2 ² / ₃₂ × 3 ¹ / ₃₂	5 ¹ / ₁₆
		Obround	3 ³ / ₃₂ × 4 ¹ / ₃₂	3 ³ / ₈
		Obround	4 × 6	3 ³ / ₈
Combustion Eng.	1N-L1272	Round	1 ¹ / ₂	3 ¹ / ₁₆
	7N-L1131	Round	1 ¹ / ₄	3 ¹ / ₁₆
	3N-L1274	Round	2 ⁵ / ₈	7 ¹ / ₃₂
	4N-L740	Round	3 ¹ / ₈	1 ¹ / ₄
	L741	Round	3 ³ / ₈	1 ¹ / ₄
	PB9474	Round	3 ¹ / ₂	3 ¹ / ₁₆
	5N-L902	Round	3 ³ / ₈	1 ¹ / ₄
	21N-L1291 (609)	Obround	2 ¹ / ₈ × 2 ¹ / ₂	5 ¹ / ₃₂
	23N	Obround	2 ² / ₃₂ × 3 ¹ / ₃₂	7 ¹ / ₃₂
	25N-L1278	Obround	3 ¹ / ₈ × 4 ¹ / ₈	3 ¹ / ₁₆ or 1 ¹ / ₄
	28N-L1277 (612)	Obround	3 ³ / ₈ × 3 ³ / ₈	3 ¹ / ₁₆ or 1 ¹ / ₄
	PB9474	Obround	4 ¹ / ₈ × 4 ¹ / ₈	3 ¹ / ₁₆
	51N	Rect.	4 ¹ / ₁₆ × 5	7 ¹ / ₃₂
	52N-L1117	Rect.	4 ³ / ₈ × 5 ³ / ₁₆	7 ¹ / ₃₂
	22N (610)	Oval	2 ¹ / ₈ × 2 ⁵ / ₈	7 ¹ / ₃₂
	32N	Oval	4 ¹ / ₂ × 5 ¹ / ₂	7 ¹ / ₃₂
	24N-L1206 (611)	Diamond	3 × 3 ⁷ / ₈	1 ¹ / ₄
	27N	Diamond	3 ³ / ₈ × 3 ³ / ₄	3 ¹ / ₁₆
	29N-L839 (614)	Diamond	3 ³ / ₈ × 4 ¹ / ₄	1 ¹ / ₄
	30N-L866	Diamond	3 ³ / ₈ × 4 ¹ / ₂	1 ¹ / ₄
	33N-L1205 (616)	Diamond	3 ³ / ₄ × 4 ³ / ₈	1 ¹ / ₄
	31N-L579	Diamond	4 ¹ / ₄ × 5 ¹ / ₈	1 ¹ / ₄
Edge Moor		Round	2 ¹ / ₂	1 ¹ / ₂
		Round	4 ¹ / ₁₆	1 ⁵ / ₃₂
		Oval	4 ¹ / ₈ × 5 ¹ / ₄	3 ³ / ₈
Erie City		Round	3 ¹ / ₂	3 ³ / ₈
		Obround	3 × 4 ¹ / ₂	3 ³ / ₈
		Oval	3 ¹ / ₃₂ × 4 ¹ / ₃₂	3 ¹ / ₁₆
		Oval	3 ¹ / ₃₂ × 4 ¹ / ₃₂	5 ¹ / ₁₆
		Oval	4 ¹ / ₃₂ × 5 ¹ / ₃₂	7 ¹ / ₁₆
		Oval	4 ¹ / ₃₂ × 6 ¹ / ₃₂	3 ³ / ₈
		Pear	3 ¹ / ₂ × 4 ³ / ₈	3 ³ / ₈
Foster-Wheeler		Round	7 ¹ / ₈	3 ¹ / ₁₆
		Round	1 ⁵ / ₁₆	7 ¹ / ₃₂
		Round	2 ¹ / ₃₂	1 ³ / ₁₆₄ or 1 ⁵ / ₁₆₄
		Round	2 ¹ / ₈ or 2 ¹ / ₁₆	3 ³ / ₈
		Round	3 ¹ / ₈ or 3 ¹ / ₁₆	3 ³ / ₈

Make of Boiler	Gasket Number	Shape	Nominal Size Inside Dimensions (Inches)	Flange Width (Inches)
Foster-Wheeler (continued)		Round	4 ¹ / ₈ or 4 ¹ / ₁₆	3 ³ / ₈
		Obround	2 ¹ / ₃₂ × 2 ¹ / ₃₂	1 ³ / ₁₆₄
	2 ³ / ₄ " (1003)	Obround	2 ² / ₃₂ × 3 ¹ / ₃₂	7 ¹ / ₃₂
		Obround	3 × 4	3 ³ / ₈
	3 ¹ / ₁₆ " (1004)	Obround	3 ¹ / ₃₂ × 3 ³ / ₃₂	7 ¹ / ₃₂
		Rect.	4 ¹ / ₁₆ × 5 ³ / ₁₆	7 ¹ / ₃₂
	(1005)	Oval	4 ³ / ₁₆ × 5 ³ / ₁₆	5 ¹ / ₁₆
		Diamond	4 × 5	3 ¹ / ₈
Geary	3 ¹ / ₂ "	Obround	3 ¹ / ₁₆ × 4 ³ / ₈	3 ³ / ₈
	4"	Obround	4 ¹ / ₄ × 5 ¹ / ₄	7 ¹ / ₁₆
	4"*	Obround	4 ¹ / ₄ × 5 ¹ / ₄	7 ¹ / ₁₆
Heine		Round	3 ³ / ₈	3 ³ / ₈
		Obround	3 ³ / ₈ × 4 ⁵ / ₈	3 ³ / ₈
Keeler		Round	4 ¹ / ₄	3 ³ / ₈
		Obround	3 × 4	3 ³ / ₈
		Diamond	4 ¹ / ₄ × 5 ¹ / ₄	3 ³ / ₈
Murray		Obround	3 ³ / ₈ × 4 ¹ / ₁₆	7 ¹ / ₁₆
		Obround	4 ¹ / ₃₂ × 4 ² / ₃₂	3 ³ / ₈
Oil Field		Obround	2 ¹ / ₂ × 3 ¹ / ₂	3 ³ / ₈
		Oval	3 × 4	3 ³ / ₈
		Oval	3 ¹ / ₂ × 4 ¹ / ₂	3 ³ / ₈
		Oval	4 ¹ / ₁₆ × 5 ¹ / ₁₆	7 ¹ / ₁₆
Pacific		Round	1 ¹ / ₂	1 ¹ / ₂
		Round	2	1 ¹ / ₂
		Round	2 ¹ / ₂	1 ¹ / ₂
Riley Stoker	W-C16	Round	1 ³ / ₃₂	3 ³ / ₈
	W-C6	Round	3 ³ / ₃₂	5 ¹ / ₁₆
	W-C2	Obround	3 ² / ₃₂ × 5 ² / ₃₂	1 ¹ / ₃₂
	W-C9	Square	4 × 4	1 ¹ / ₃₂
	W-C12	Square	5 ¹ / ₂ × 5 ¹ / ₂	3 ³ / ₈
	W-C22	Oval	3 ¹ / ₃₂ × 4 ¹ / ₃₂	5 ¹ / ₁₆
Springfield		Square	5 ¹ / ₂ × 5 ¹ / ₂	3 ³ / ₈
		Oval	3 ¹ / ₃₂ × 4 ¹ / ₃₂	5 ¹ / ₁₆
		Oval	4 ¹ / ₁₆ × 5 ¹ / ₁₆	3 ³ / ₈
Superheater		Round	1 ⁵ / ₁₆	3 ¹ / ₁₆
		Round	3 ³ / ₃₂	1 ¹ / ₄
		Obround	2 ² / ₃₂ × 3 ⁹ / ₃₂	1 ⁵ / ₁₆₄
		Obround	3 ³ / ₃₂ × 4 ³ / ₃₂	1 ¹ / ₄
		Obround	3 ¹ / ₃₂ × 3 ² / ₃₂	3 ¹ / ₁₆
		Obround	3 ³ / ₈ × 3 ⁷ / ₈	1 ¹ / ₄
Union		Oval	3 ¹ / ₂ × 4 ¹ / ₂	3 ³ / ₈
		Pear	3 ¹ / ₁₆ × 4 ¹ / ₁₆	3 ³ / ₈
		Pear	3 ¹ / ₂ × 4 ¹ / ₂	3 ³ / ₈
		Pear	4 ¹ / ₈ × 5 ¹ / ₄	3 ³ / ₈
		Pear	4 ¹ / ₄ × 5 ¹ / ₄	3 ³ / ₈
Vogt		Round	3 ¹ / ₃₂	3 ³ / ₈
		Round	3 ³ / ₈	3 ³ / ₈
		Round	4 ¹ / ₈	3 ³ / ₈
		Oval	3 × 4	5 ¹ / ₁₆
		Oval	3 ³ / ₈ × 4 ¹ / ₄	7 ¹ / ₃₂
		Oval	3 ¹ / ₂ × 4 ¹ / ₂	5 ¹ / ₁₆
		Oval	3 ³ / ₄ × 5	3 ³ / ₈
		Oval	4 × 5	5 ¹ / ₁₆
		Oval	4 × 6	3 ³ / ₈
		Oval	4 ¹ / ₄ × 5 ¹ / ₈	7 ¹ / ₃₂
		Oval	4 ¹ / ₄ × 5 ¹ / ₈	5 ¹ / ₁₆
		Oval	4 ⁹ / ₃₂ × 5 ⁵ / ₃₂	7 ¹ / ₃₂
Wickes		Round	4 ¹ / ₈	3 ³ / ₈
		Round	4 ¹ / ₄	3 ³ / ₈
	D2300	Oval	3 × 4	5 ¹ / ₁₆
	D2301	Oval	3 ¹ / ₂ × 4 ¹ / ₂	5 ¹ / ₁₆
	D2361	Oval	4 × 5	5 ¹ / ₁₆
	D2724	Oval	4 × 6	5 ¹ / ₁₆
		Pear	4 ¹ / ₈ × 5 ¹ / ₈	9 ¹ / ₃₂
		Pear	4 ¹ / ₄ × 5 ¹ / ₈	3 ³ / ₈

*.285 thick